

Always check the website for the most updated specifications: www.americh.com

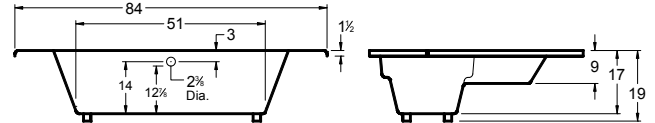

Tub pictured with optional waste & overflow.

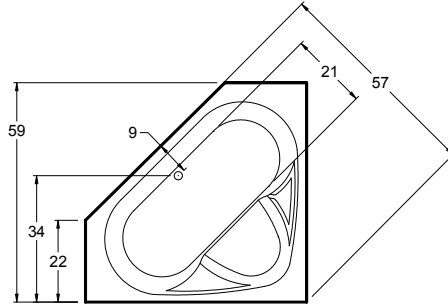

All bathtub dimensions are ± 1/2".

Builder Series

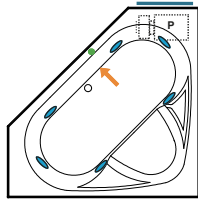

Luxury Series

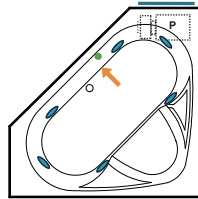

Platinum Series

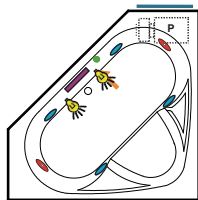

Combination

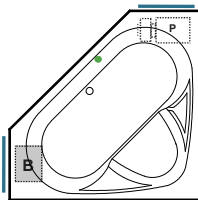

Airbath System II

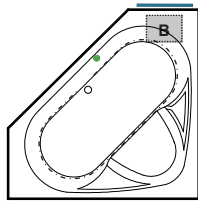

Airbath System

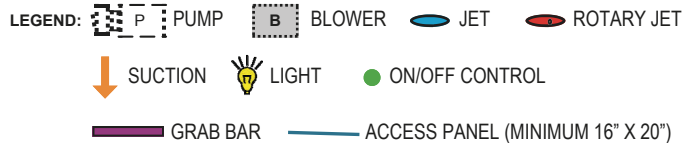
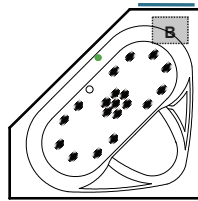

INSTALLATION TIPS

- Install according to Owner's Manual and local codes. Always consult your local plumber for recommendations.
 - Certain options or altering the pump/blower location may cause the pump/blower to extend beyond the tub decking.
 - Airbath III units may be 1 1/2" – 2 1/2" taller than stated.
 - Hot water supply should be 65-75% of the tub capacity or greater.
 - Cut Dimensions: Americh recommends waiting until the actual unit is received.
 - All specifications are subject to change without notice
- ++ Factory installed aprons on this model may increase the overall height of the tub when ordered with certain accessories (.IE Linear Drain)

DIMENSIONS

59" x 59" x 19" deep (1499 x 1499 x 483 mm)
 Whirlpool Operating Gallons = 50 (Liters = 189)
 Gallon to Overflow = 65 (Liters = 246)

MATERIAL: Acrylic (All Americh Standard Colors)

TUB FLOOR: Textured

UNDERMOUNT: No

ELECTRICAL REQUIREMENTS

Americh recommends one 20 amp ground fault circuit interrupter (GFCI) for each power supply provided with the bathtub.

OPTIONAL ACCESSORIES

- Bermuda Apron ++
- Chromatherapy*
- Grab Bars: 9" * - 14" - 16"
- High Density Insulation*
- iBath Sound System
- Inline Heater (whirlpool only)
- Jets: Additional or Rotary*
- Lo Profile Tub Edge
- Ozone System (whirlpool and/or Airbath only)
- Pillows: 13" *
 Angle - Full Back
- Remote Control Upgrade (select series only)
- Serenity Soak (tub only)
- Syllent Pump with Heated Air*
- Tile Flange Kit
- Trim Kit Upgrade*
- Waste & Overflow
 - Cable Drive Overflow*
 - Linear Overflow

*Standard on Platinum Series

CODES AND COMPLIANCE

Americh products meet or exceed the following standards:

- Underwriters Laboratories (UL)
- Underwriters Laboratories - Canada (cUL)
- Canadian Standards Association - (CSA)
- ANSI Z124.1 • ANSI A112-19.7