

- EN** Installation / User Instructions / Warranty  
**FR** Instructions de montage / Mode d'emploi / Garantie  
**ES** Instrucciones de montaje / Manejo / Garantía

This unit is listed by IAPMO for use in the USA and Canada.

This unit meets or exceeds the following:

- ASME A112.18.1
- CSA B125.1

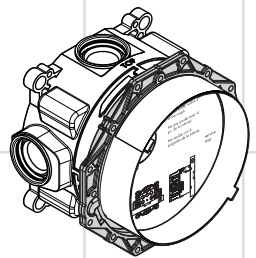

**iBox Universal Plus  
Rough**  
01850181

## Technical Information / Données techniques / Datos técnicos

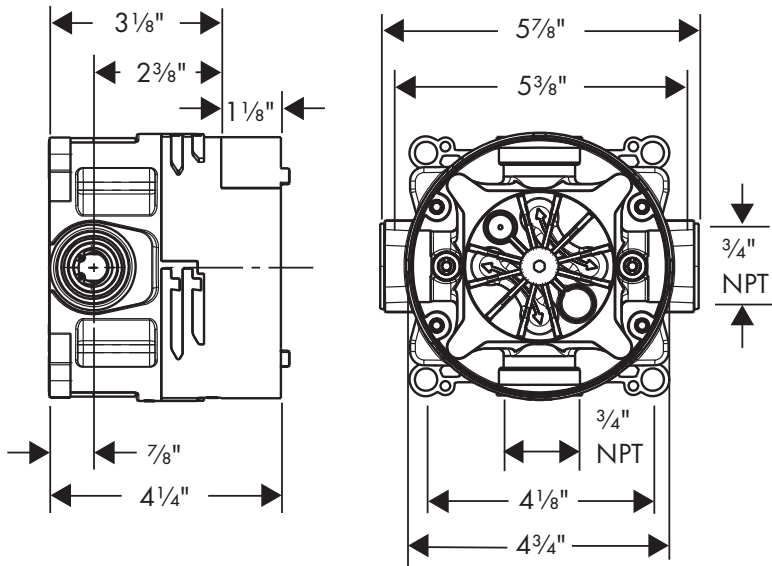

Recommended water pressure	Pression de service conseillée	Presión recomendada en servicio	15 - 75 PSI
Max. water pressure	Pression de service max.	Presión máximo en servicio	145 PSI
Recommended hot water temp.	Température recommandée	Temp. recomendada del agua caliente	120° - 140° F
Max. hot water temp.	Température max. d'eau chaude	Temperatura max. del agua caliente	180° F
Max. flow rate @ 44 PSI	Capacité nominale @ 44 PSI	Caudal máximo @ 44 PSI	
Thermostatic mixer	Mitigeur thermostatique	Mezclador termostático	13 GPM
Thermostat with volume control	Mitigeur thermostatique avec contrôle de débit	Mezclador termostático con llave de paso	6.0 GPM
Thermostat with volume control /diverter	Mitigeur thermostatique avec contrôle de débit/inverseur	Mezclador termostático con llave de paso / distribuidor	7.0 GPM
Pressure balance valve	Mitigeur équilibrage de pression	Válvula de presión balanceada	5.5 GPM
Pressure balance valve with diverter	Mitigeur équilibrage de pression avec inverseur	Válvula de presión balanceada y distribuidor	4.5 GPM
Connections	Connexions	Conexiones	¾" NPT female cold right / hot left

\*Please know and follow all applicable local plumbing codes when setting the temperature on the water heater.

\* Vous devez connaître et respecter tous les codes de plomberie locaux applicables pour le réglage de la température du chauffe-eau.

\*Debe conocer y cumplir todos los códigos locales aplicables para ajustar la temperatura del calentador de agua

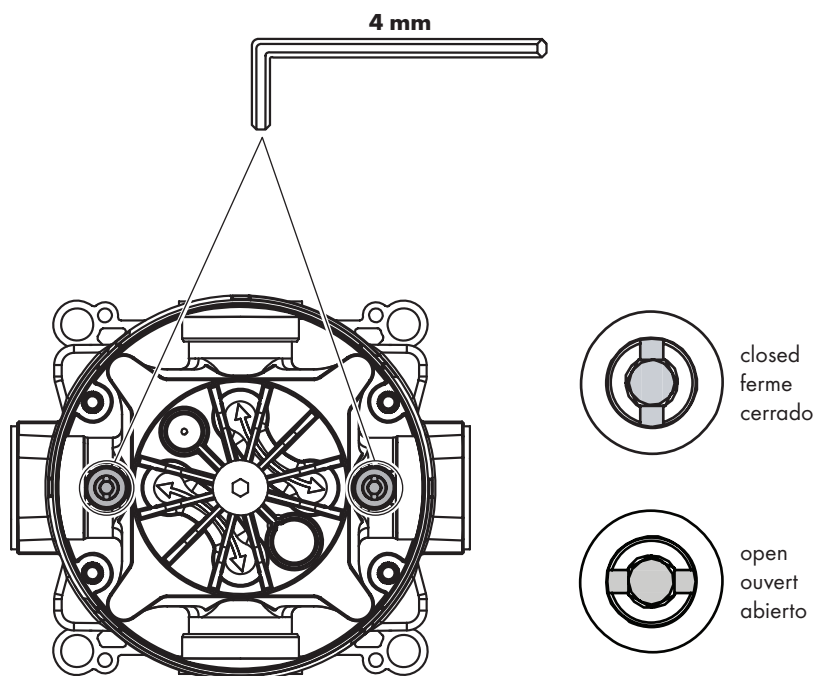

## English

English.....	5
Mixing valve trim kits.....	6
Replacement parts.....	11
Installation options.....	12
Installation.....	16
Installation Suggestions.....	22
Symbols.....	23
Thermostatic mixer.....	25-33
Thermostat w/shutoff.....	34-37
Thermostat w/shutoff & diverter.....	38-40
Pressure balance valve.....	34-36, 41
Pressure balance w/diverter.....	42-44
Axor Urquiola 11435xx1.....	30
Raindance 28411xx1.....	31
Raindance 27373xx1.....	32
Raindance 28417xx1, 28403xx1.....	33
Raindance 28433xx1.....	37
Raindance S Showerpipe 27192xx1.....	45

## Français

Français .....	7
Jeu de garniture .....	8
Pièces détachées .....	11
Options d'installation .....	12
Installation .....	16
Suggestions d'installation .....	22
Symboles .....	23
Mitigeur thermostatique .....	25-33
Mitigeur thermostatique avec robinet d'arrêt .....	34-37
Mitigeur thermostatique avec robinet d'arrêt et inverseur .....	38-40
Mitigeur équilibrage de pression .....	34-36, 41
Mitigeur équilibrage de pression avec inverseur .....	42-44
Axor Urquiola 11435xx1 .....	30
Raindance 28411xx1 .....	31
Raindance 27373xx1 .....	32
Raindance 28417xx1, 28403xx1 .....	33
Raindance 28433xx1 .....	37
Raindance S Showerpipe 27192xx1 .....	45

## Español

Español .....	9
Juegos de piezas exteriores .....	10
Repuestos .....	11
Opciones de instalación .....	12
Instalación .....	16
Sugerencias de instalación .....	22
Símbolos .....	23
Termostato .....	25-33
Termostato con llave de paso .....	34-37
Termostato con llave de paso y distribuidor .....	38-40
Válvula de presión balanceada .....	34-36, 41
Válvula de presión balanceada con distribuidor .....	42-44
Axor Urquiola 11435xx1 .....	30
Raindance 28411xx1 .....	31
Raindance 27373xx1 .....	32
Raindance 28417xx1, 28403xx1 .....	33
Raindance 28433xx1 .....	37
Raindance S Showerpipe 27192xx1 .....	45

## Installation Considerations

- For best results, Hansgrohe recommends that this unit be installed by a licensed, professional plumber.
- Please read over these instructions thoroughly before beginning installation. Make sure that you have all tools and supplies needed to complete the installation.
- Do not remove the plastic installation box from the valve.
- The cartridge is included with the trim kit. The cartridge will vary, according to the type of trim kit.
- The cartridge has an integrated high temperature limit stop which may be reset to comply with local plumbing codes.
- To prevent scald injury, the maximum output temperature of the shower valve must be no higher than 120°F. In Massachusetts the maximum output temperature of the shower valve can be no higher than 112°F.

### Important



**The outside surface of the finished wall must fall between the "min" and "max" markings on the iBox.**

- Some municipalities do not permit installations that allow the use of two or more shower functions simultaneously. Please know and follow all applicable local plumbing codes.



**Know in advance what type of trim kit is to be used. Installation requirements vary. Additional valve(s) may be required. Please refer to the following page.**



**For correct function of the valve, the hot supply must be plumbed to the hot inlet (left horizontal side) and the cold supply must be plumbed to the cold inlet (right horizontal side).**

- The connections on the valve are  $\frac{3}{4}$  NPT.  $\frac{1}{2}$  NPT lines may be used if suitable for the installation. The installer must provide  $\frac{3}{4}$  -  $\frac{1}{2}$  adapters.
- Protect the rough from freeze damage. In the event of freezing temperatures, drain the pipes.

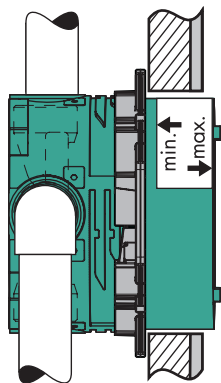





### Important

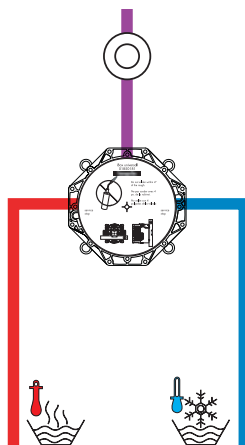

**For correct operation of the thermostatic mixer valve, the hot supply must be plumbed to the hot (left horizontal) inlet, and the cold supply must be plumbed to the cold (right horizontal) inlet.**

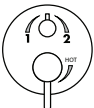

## Mixing Valve Trim Kits

Trim Type	Best for	Use with	! Don't use with
Thermostatic mixing valve 	<ul style="list-style-type: none"> <li>Single- or multiple-feature showers</li> <li>Use one or both outlets</li> </ul> <p>! <b>Provide volume control for each outlet</b></p>	<ul style="list-style-type: none"> <li>Volume control valve 15974181 (1/2") or 15977181 (3/4")</li> <li>Trio diverter 15984181</li> <li>Trio diverter with shutoff 15981181</li> <li>Quattro diverter 15930181 or 15936181</li> <li>FixFit wall outlet</li> </ul>	<ul style="list-style-type: none"> <li>Diverter tub spout</li> </ul>
Thermostat with shutoff 	<ul style="list-style-type: none"> <li>Single feature shower</li> </ul> <p>! <b>Use only one outlet!</b></p>	<ul style="list-style-type: none"> <li>Trio diverter 15984181</li> <li>Quattro diverter 15930181 or 15936181</li> </ul>	<ul style="list-style-type: none"> <li>Diverter tub spout</li> <li>Any valve with positive shutoff</li> <li>Volume control valve 15974181 (1/2") or 15977181 (3/4")</li> <li>FixFit wall outlet</li> <li>Trio diverter with shutoff 15981181</li> </ul>
Thermostat with shutoff and diverter 	<ul style="list-style-type: none"> <li>Two-feature shower</li> </ul> <p>! <b>Both outlets must be used.</b></p> <p>! <b>Do not plug either outlet.</b></p>	<ul style="list-style-type: none"> <li>Trio Diverter 15984181</li> <li>Quattro diverter 15930181 or 15936181</li> </ul>	<ul style="list-style-type: none"> <li>Diverter tub spout</li> <li>Any valve with positive shutoff</li> <li>Volume control valve 15974181 (1/2") or 15977181 (3/4")</li> <li>FixFit wall outlet</li> <li>Trio diverter with shutoff 15981181</li> </ul>
Pressure balance valve 	<ul style="list-style-type: none"> <li>One-feature shower</li> <li>Tub/shower with diverter tub spout</li> </ul>	<ul style="list-style-type: none"> <li>Trio Diverter 15984181</li> <li>Quattro diverter 15930181 or 15936181</li> <li>Diverter tub spout</li> </ul>	<ul style="list-style-type: none"> <li>Any valve with positive shutoff</li> <li>Volume control valve 15974181 (1/2") or 15977181 (3/4")</li> <li>FixFit wall outlet</li> <li>Trio diverter with shutoff 15981181</li> </ul>
Pressure balance with diverter 	<ul style="list-style-type: none"> <li>Two-feature shower</li> </ul> <p>! <b>Both outlets must be used.</b></p> <p>! <b>Do not plug either outlet.</b></p>	<ul style="list-style-type: none"> <li>Trio Diverter 15984181</li> <li>Quattro diverter 15930181 or 15936181</li> </ul>	<ul style="list-style-type: none"> <li>Diverter tub spout</li> <li>Any valve with positive shutoff</li> <li>Volume control valve 15974181 (1/2") or 15977181 (3/4")</li> <li>FixFit wall outlet</li> <li>Trio diverter with shutoff 15981181</li> </ul>

## À prendre en considération pour l'installation

- Pour de meilleurs résultats, Hansgrohe recommande que ce produit soit installé par un plombier professionnel licencié.
- Veuillez lire attentivement ces instructions avant de procéder à l'installation. Assurez-vous de disposer de tous les outils et du matériel nécessaires pour l'installation.
- Ne retirez pas la boîte d'installation en plastique du robinet.
- La cartouche est comprise avec le jeu de garniture. La cartouche variera selon le type de jeu de garniture.
- La cartouche dispose d'une butée de limite d'eau chaude qui peut être réglée de façon à satisfaire aux codes de plomberie locaux.
- Pour empêcher des blessures par ébullition, la température de sortie maximale du robinet de douche ne doit pas excéder 120°F. Au Massachusetts, la température de sortie maximale du robinet de douche ne doit pas excéder 112°F.



**Déterminez à l'avance le type de jeu de garniture à utiliser. Les exigences d'installation varient. Il pourra être nécessaire d'utiliser des robinets supplémentaires. S'il vous plaît se référez à page 8.**



**Pour que le robinet fonctionne correctement, la conduite d'alimentation de l'eau chaude doit être installée dans l'orifice d'arrivée prévu pour l'eau chaude (l'horizontale latérale gauche), et la conduite d'eau froide doit être installée dans l'orifice d'arrivée prévu pour l'eau froide (l'horizontale latérale droite).**

- Protégez la pièce intérieure des dommages occasionnés par le gel. Vidangez les tuyaux si les températures sont au-dessous du point de congélation.

### Avis



**Installez le robinet de façon à ce que la surface extérieure du mur fini se trouve entre les lignes « minimum » et « maximum ».**

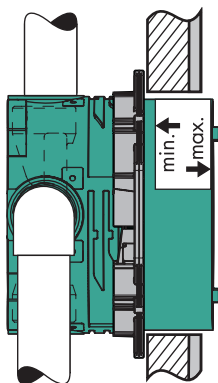





### Avis

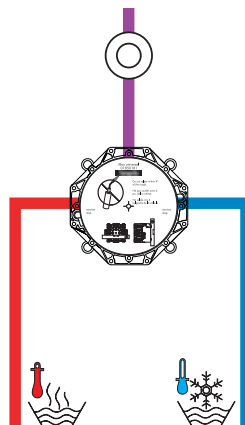

**Pour que le mitigeur thermostatique fonctionne correctement, la conduite d'alimentation de l'eau chaude doit être installée dans l'orifice d'arrivée prévu pour l'eau chaude (l'horizontale latérale gauche), et la conduite d'eau froide doit être installée dans l'orifice d'arrivée prévu pour l'eau froide (l'horizontale latérale droite).**

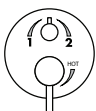

**Jeu de Garniture**

	<b>Usage</b>	<b>Utiliser avec</b>	<b>! Ne pas utiliser avec</b>
Mitigeur thermostatique 	<ul style="list-style-type: none"> <li>Installation à une fonction</li> <li>Installation de multiple-fonctions</li> </ul> <b>! Fournit un robinet d'arrêt pour chaque orifice de sortie.</b>	<ul style="list-style-type: none"> <li>Robinet d'arrêt 15974181 (1/2") ou 15977181 (3/4")</li> <li>Trio inverseur 15984181</li> <li>Trio inverseur avec robinet d'arrêt 15981181</li> <li>Quattro inverseur 15930181 or 15936181</li> <li>FixFit wall outlet</li> </ul>	<ul style="list-style-type: none"> <li>Bec de baignoire inverseur</li> </ul>
Mitigeur thermostatique avec robinet d'arrêt 	<ul style="list-style-type: none"> <li>Installation à une fonction</li> </ul> <b>! N'installez qu'à une seule conduite de sortie.</b>	<ul style="list-style-type: none"> <li>Trio inverseur 15984181</li> <li>Quattro inverseur 15930181 or 15936181</li> </ul>	<ul style="list-style-type: none"> <li>Bec de baignoire inverseur</li> <li>Dispositif d'arrêt</li> <li>Robinet d'arrêt 15974181 (1/2") or 15977181 (3/4")</li> <li>FixFit wall outlet</li> <li>Trio inverseur avec robinet d'arrêt 15981181</li> </ul>
Mitigeur thermostatique avec robinet d'arrêt et inverseur 	<ul style="list-style-type: none"> <li>Installation à deux fonctions</li> </ul> <b>! N'utilisez pas cette option pour une douche à une fonction.</b>	<ul style="list-style-type: none"> <li>Trio inverseur 15984181</li> <li>Quattro inverseur 15930181 or 15936181</li> </ul>	<ul style="list-style-type: none"> <li>Bec de baignoire inverseur</li> <li>Dispositif d'arrêt</li> <li>Robinet d'arrêt 15974181 (1/2") or 15977181 (3/4")</li> <li>FixFit wall outlet</li> <li>Trio inverseur avec robinet d'arrêt 15981181</li> </ul>
Mitigeur équilibrage de pression 	<ul style="list-style-type: none"> <li>Installation à une fonction</li> <li>Douche/baignoire avec bec de baignoire inverseur</li> </ul>	<ul style="list-style-type: none"> <li>Trio inverseur 15984181</li> <li>Quattro inverseur 15930181 or 15936181</li> <li>Bec de baignoire inverseur</li> </ul>	<ul style="list-style-type: none"> <li>Dispositif d'arrêt</li> <li>Robinet d'arrêt 15974181 (1/2") or 15977181 (3/4")</li> <li>FixFit wall outlet</li> <li>Trio inverseur avec robinet d'arrêt 15981181</li> </ul>
Mitigeur équilibrage de pression avec inverseur 	<ul style="list-style-type: none"> <li>Installation à deux fonctions</li> </ul> <b>! N'utilisez pas cette option pour une douche à une fonction.</b>	<ul style="list-style-type: none"> <li>Trio inverseur 15984181</li> <li>Quattro inverseur 15930181 or 15936181</li> </ul>	<ul style="list-style-type: none"> <li>Bec de baignoire inverseur</li> <li>Dispositif d'arrêt</li> <li>Robinet d'arrêt 15974181 (1/2") or 15977181 (3/4")</li> <li>FixFit wall outlet</li> <li>Trio inverseur avec robinet d'arrêt 15981181</li> </ul>



## Consideraciones para la instalación

- Para obtener mejores resultados, Hansgrohe recomienda que la instalación de esta unidad esté a cargo de un plomero profesional matriculado.
- Antes de comenzar la instalación, lea estas instrucciones detenidamente. Asegúrese de tener las herramientas y los insumos necesarios para completar la instalación.
- No retire la caja de instalación plástica de la válvula.
- El cartucho está incluido en el juego de la pieza exterior. El cartucho varía de acuerdo al tipo de juego de pieza exterior.
- El cartucho tiene un cierre de límite de alta temperatura que se puede reajustar para cumplir los códigos de plomería locales.
- Al prevenir escaldar herida, la temperatura de salida máxima de la válvula de chaparrón no

debe ser más alto que 120 °F. En Massachusetts: la temperatura de salida máxima de la válvula no puede ser más alto que 112 °F.

**!** **Conozca de antemano qué tipo de juego de pieza exterior va a usar. Los requisitos de instalación varían. Pueden requerirse una o más válvulas adicionales. Refiérase por favor para página 10.**

**!** **Para que la válvula funcione correctamente, el suministro de agua caliente se debe conectar a la entrada de agua caliente (lado horizontal izquierdo) y el de agua fría a la entrada de agua fría (lado horizontal derecho).**

- Proteja la pieza interior contra los daños por congelamiento. En caso de temperaturas de congelamiento, drene las cañerías.

### Aviso



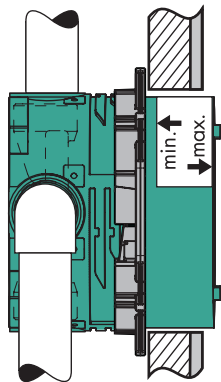

**!** **Instale la válvula de modo que la superficie exterior de la pared terminada quede entre las marcas "min" y "max".**

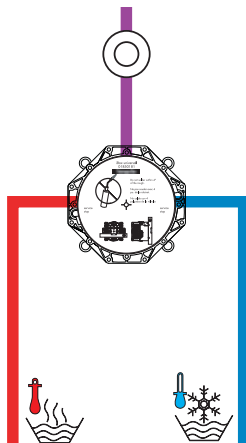

### Avis

**!** **Para que la válvula del mezclador termostático funcione correctamente, el suministro de agua caliente se debe conectar a la entrada de agua caliente (lado horizontal izquierdo) y el de agua fría a la entrada de agua fría (lado horizontal derecho).**



	Uso	Utilice con	❗ No utilice con
<p>Termostato</p> 	<ul style="list-style-type: none"> <li>• Instalación de una sola función</li> <li>• Instalación de varias funciones</li> </ul> <p>❗ <b>Proporcione llave de paso para cada toma .</b></p>	<ul style="list-style-type: none"> <li>• Llave de paso 15974181 (1/2") ou 15977181 (3/4")</li> <li>• Trio distribuidor 15984181</li> <li>• Trio distribuidor con llave de paso 15981181</li> <li>• Quattro distribuidor 15930181 o 15936181</li> <li>• FixFit wall outlet</li> </ul>	<ul style="list-style-type: none"> <li>• Surtidor de bañera tipo distribuidor</li> </ul>
<p>Termostato con llave de paso</p> 	<ul style="list-style-type: none"> <li>• Instalación de una sola función</li> </ul> <p>❗ <b>Conecte desde una toma solamente</b></p>	<ul style="list-style-type: none"> <li>• Trio distribuidor 15984181</li> <li>• Quattro distribuidor 15930181 o 15936181</li> </ul>	<ul style="list-style-type: none"> <li>• Surtidor de bañera tipo distribuidor</li> <li>• Llave de paso 15974181 (1/2") o 15977181 (3/4")</li> <li>• FixFit wall outlet</li> <li>• Trio distribuidor con llave de paso 15981181</li> </ul>
<p>Termostato con llave de paso y distribuidor</p> 	<ul style="list-style-type: none"> <li>• Instalación de dos funciones</li> </ul> <p>❗ <b>No use para duchas de una sola función.</b></p>	<ul style="list-style-type: none"> <li>• Trio distribuidor 15984181</li> <li>• Quattro distribuidor 15930181 o 15936181</li> </ul>	<ul style="list-style-type: none"> <li>• Surtidor de bañera tipo distribuidor</li> <li>• Dispositif d'arrêt</li> <li>• Llave de paso 15974181 (1/2") o 15977181 (3/4")</li> <li>• FixFit wall outlet</li> <li>• Trio distribuidor con llave de paso 15981181</li> </ul>
<p>Válvula de presión balanceada</p> 	<ul style="list-style-type: none"> <li>• Instalación de una sola función</li> <li>• Bañera/ducha con un surtidor de bañera tipo distribuidor</li> </ul>	<ul style="list-style-type: none"> <li>• Trio distribuidor 15984181</li> <li>• Quattro distribuidor 15930181 o 15936181</li> <li>• Surtidor de bañera tipo distribuidor</li> </ul>	<ul style="list-style-type: none"> <li>• Llave de paso 15974181 (1/2") o 15977181 (3/4")</li> <li>• FixFit wall outlet</li> <li>• Trio distribuidor con llave de paso 15981181</li> </ul>
<p>Válvula de presión balanceada con distribuidor</p> 	<ul style="list-style-type: none"> <li>• Instalación de dos funciones</li> </ul> <p>❗ <b>No use para duchas de una sola función.</b></p>	<ul style="list-style-type: none"> <li>• Trio distribuidor 15984181</li> <li>• Quattro distribuidor 15930181 o 15936181</li> </ul>	<ul style="list-style-type: none"> <li>• Surtidor de bañera tipo distribuidor</li> <li>• Llave de paso 15974181 (1/2") o 15977181 (3/4")</li> <li>• FixFit wall outlet</li> <li>• Trio distribuidor con llave de paso 15981181</li> </ul>

# Replacement Parts / Pièces détachées / Repuestos

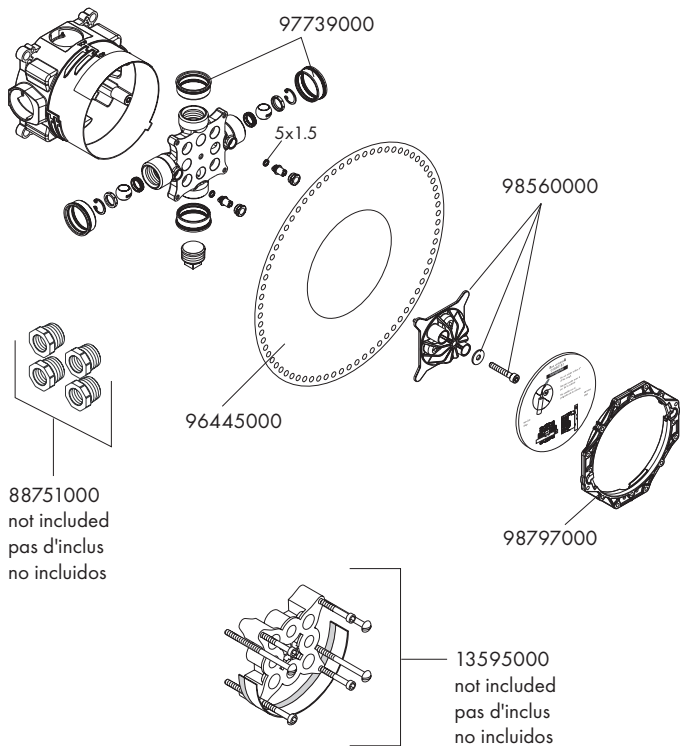

**Installation Options**

It is possible to support the iBox Plus Universal using a stringer and screws (not included).

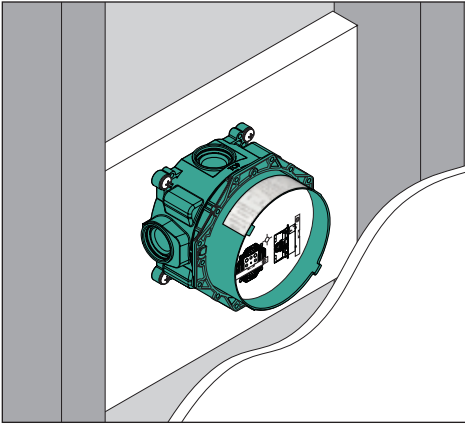

The valve may also be supported using installation kit 96615000 (not included).

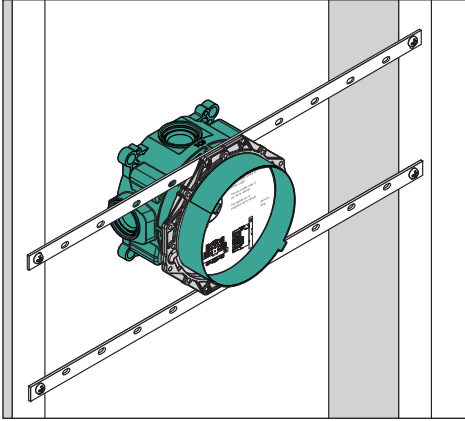

**Optional:** If using 1/2" lines, install 3/4"-1/2" NPT adapters (not included).



**Tighten the adapter fully before installing the 1/2" pipe.**

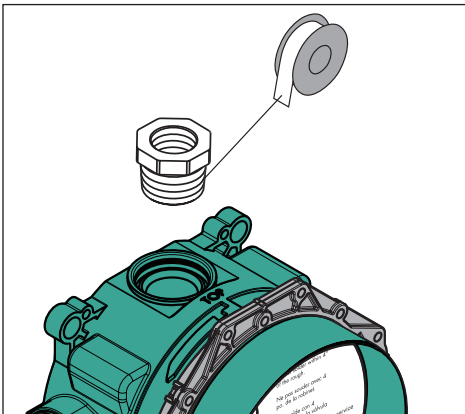

## Français

### Options d'installation

C'est possible de soutenir le robinet utilisant un plaque arrière et vis (pas inclus).

C'est aussi possible à soutenir le robinet utilisant set d'installation 96615000 (pas inclus).

**En option:** Installez le(s)  $\frac{1}{2}$  po adaptateur(s) (ne pas inclus).



**Serrez l'adaptateur complètement avant d'installer le  $\frac{1}{2}$  po tuyau.**

## Español

### Opciones de instalación

Es posible apoyar la válvula que utiliza una placa trasera y tornillos (no incluido).

Es también posible a apoyar la válvula que utiliza set de instalación 96615000 (no incluido).

**Opcional:** Instale los  $\frac{1}{2}$ " adaptadores (no incluidos).



**Apriete el adaptador completamente antes de instalar el tubo de  $\frac{1}{2}$ ".**

## Adjust the fixing ring / Ajuster l'anneau de fixation / Ajuste el anillo de fijación

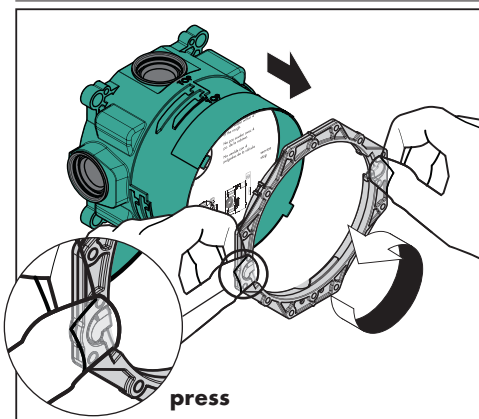

The fixing ring may be repositioned to accommodate different wall thicknesses.

L'anneau réparant pourrait être repositionné pour accommoder les épaisseurs de mur différentes.

El anillo que fija puede ser recolocado acomodar los espesores diferentes de pared.

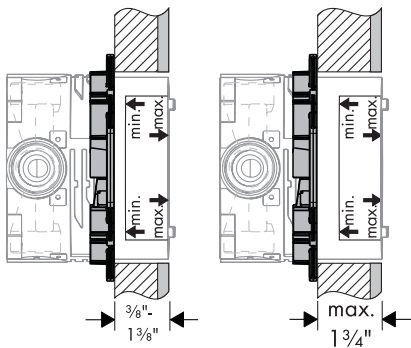
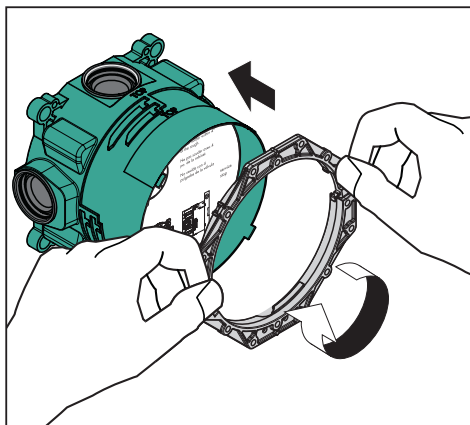

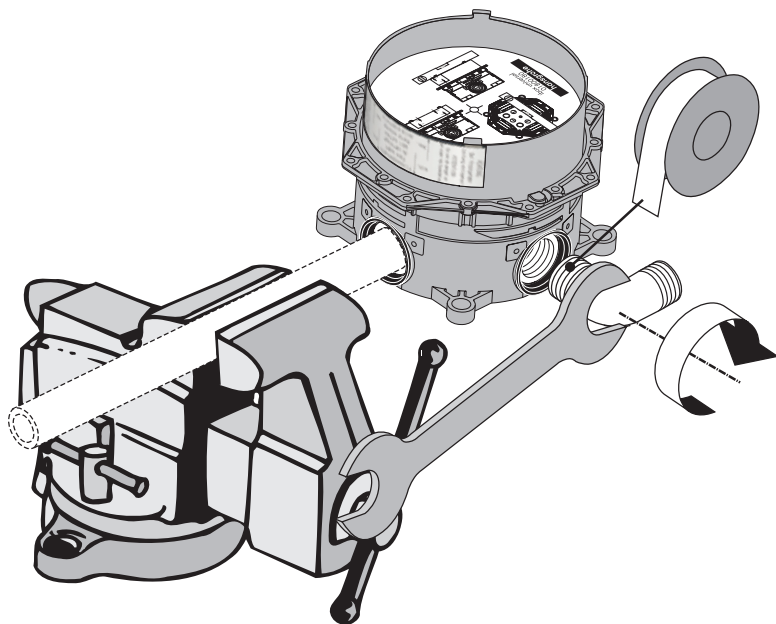

When installing the supply elbows, hold the iBox steady using a pipe and a vise.

Para enroscar los codos de conexión, fijar el iBox universal mediante un trozo de tubería en un tornillo de banco.

Pour monter les différents raccords, on peut fixer l'iBox grâce à un tuyau et un étau.

 **Do not solder within 4" of the rough, or damage to the rough may result.**

 **Aucune soudure ne peut être réalisée si la pièce intérieure se trouve à moins de 4 po sans quoi des dommages pourraient survenir.**

 **No suelde a menos de 4 pulg. de la pieza interior puesto que puede dañarla.**

**Installation**

Install the valve so that the "top" marking faces upward.

Install the hot and cold supplies on the hot inlet (left horizontal side) and cold inlet (right horizontal side).

Install the outlet line(s).

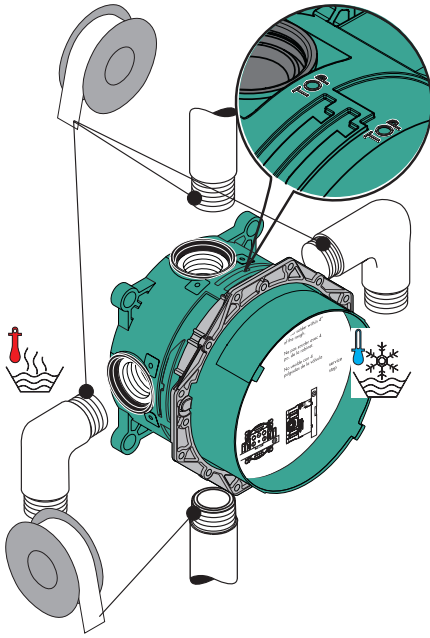

If an outlet is not to be used, seal it with a 3/4" plug (included).

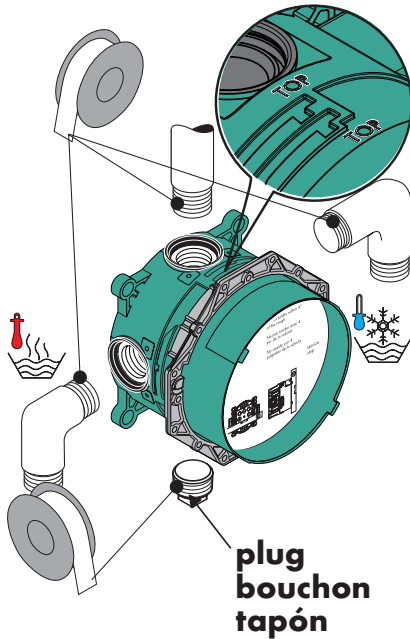

**⚠ Do not solder within 4" of the rough, or damage to the rough may result.**



## Français

### Installation

Installez le robinet de façon à ce que les faces de marquage soient dirigées vers le haut.

Raccordez les conduites d'alimentation de l'eau chaude et de l'eau froide aux orifices d'arrivée chaude (l'horizontale latérale gauche) et froide (l'horizontale latérale droite).

Installez le(s) conduite(s) de sortie.

Si vous utilisez seulement un orifice de sortie, scellez l'orifice de sortie inutilisé à l'aide d'un bouchon de 3/4 po (inclus).



**Aucune soudure ne peut être réalisée si la pièce intérieure se trouve à moins de 4 po sans quoi des dommages pourraient survenir.**

## Español

### Instalación

Instale la válvula de modo que la marca "top" mire hacia arriba.

Instale los suministros de agua caliente y fría en las entradas caliente (lado horizontal izquierdo) y fría (lado horizontal derecho).

Instale una o dos líneas en las tomas.

Si usa sólo una toma, selle la toma sin usar con un tapón de 3/4 pulg. (incluido).



**No suelde a menos de 4 pulg. de la pieza interior puesto que puede dañarla.**



**Make sure that the valve is level.**

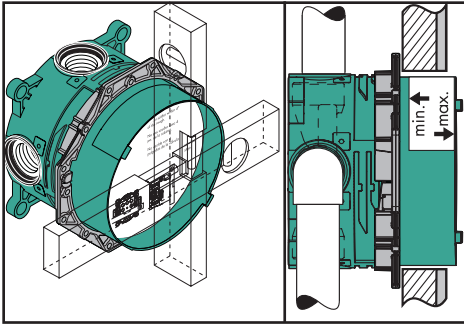

Install the valve so that the outside surface of the finished wall falls between the "min" and "max" markings.

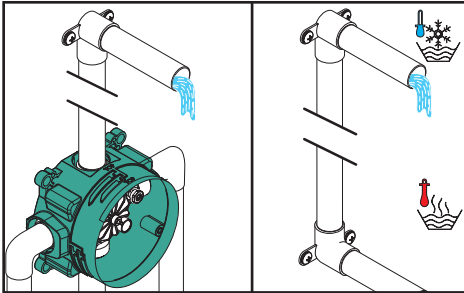

### Flush the hot and cold supplies

The hot supply will flush through the bottom outlet, and the cold supply will flush through the top outlet - see the arrows on the flushing block.

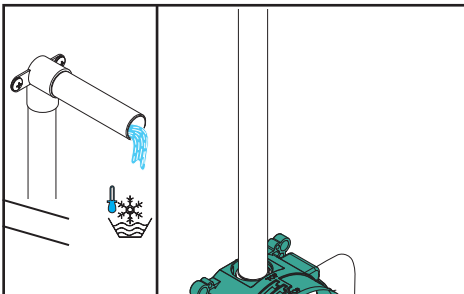

If one outlet is plugged, flush one side.

Turn the water off.

Remove the flushing block and turn it 90°.

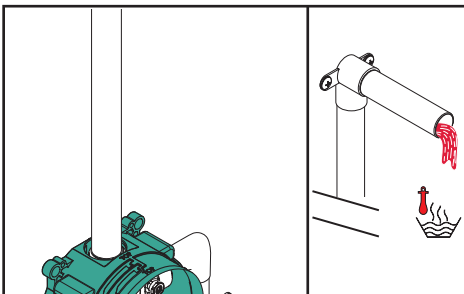

Reinstall the flushing block.

Flush the other side.

## Français



**Assurez-vous que le robinet est de niveau.**

Installez le robinet de façon à ce que la surface extérieure du mur fini se trouve entre les lignes « minimum » et « maximum ».

### Rincez les conduites d'alimentation de l'eau chaude et de l'eau froide

L'eau chaude s'écoulera par l'orifice de sortie du bas et l'eau froide par l'orifice de sortie du haut – reportez-vous aux flèches sur le bloc de rinçage.

Si un orifice est bouché, rincez l'autre côté. Coupez l'alimentation en eau.

Retirez le bloc de rinçage. Tournez-le à 90°.

Réinstallez-le.

Rincez l'autre côté.

## Español



**Asegúrese de que la válvula quede nivelada.**

Instale la válvula de modo que la superficie exterior de la pared terminada quede entre las marcas "min" y "max".

### Lave los suministros frío y caliente

El suministro de agua caliente se lava a través de la toma inferior y el de agua fría a través de la toma superior –vea las flechas del bloque de lavado.

Si una toma está taponada, lave un lado.

Cierre el paso de agua.

Retire el bloque de lavado. Gírelo 90°.

Reinstálelo.

Lave el otro lado.

### Install the finished wall

Install the tile backing board. It should come up to the iBox.

 **Seal the wall around the iBox with waterproof sealant.**

 **Failure to seal the wall can lead to possible water damage.**

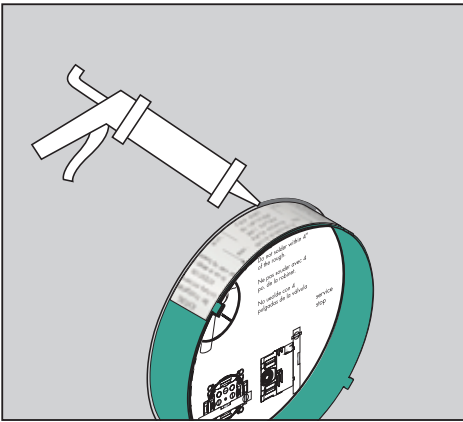

Spread waterproof adhesive (not included) on the backing board around the iBox.

 **Do not use hot glue as it will damage the gasket.**

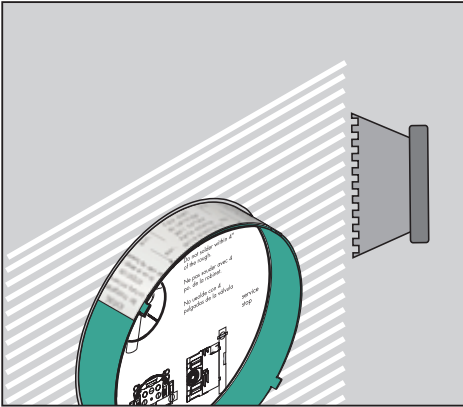

Install the gasket.

Install the tile over the gasket.

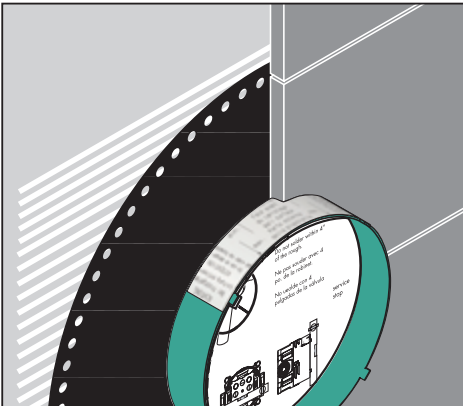

## Français

### Installez le mur fini

Installez le panneau d'appui pour carrelage. Il doit atteindre la boîte d'installation (iBox).



**Scellez le mur autour de la iBox à l'aide d'un agent d'étanchéité.**



**Si le mur n'est pas scellé, l'eau pourrait éventuellement causer des dommages.**

Appliquez un adhésif à l'épreuve de l'eau (non inclus) sur le panneau d'appui, autour de la boîte d'installation (iBox).



**N'utilisez pas de colle chaude car vous pourriez endommager le joint.**

Installez le joint.

Installez les carreaux sur le joint.

## Español

### Instale la pared terminada

Instale el tablero de soporte de los azulejos. Debe llegar hasta la caja de instalación iBox.



**Selle la pared alrededor de la iBox con un sellador impermeable.**



**Si no se sella la pared, pueden producirse daños debidos al agua.**

Aplique adhesivo (no incluido) a la pared alrededor de la válvula.



**No use cola caliente, puesto que daña la junta.**











Instale la junta.

Instale el azulejo sobre la junta.



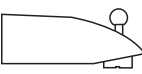
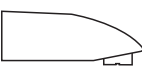

**Suggested Installations / Suggestions d'installation / Sugerencias de instalación**

Thermostatic mixer	Mitigeur thermostatique	Termostato	25 - 33
Thermostat w/shutoff	Mitigeur thermostatique avec robinet d'arrêt	Termostato con llave de paso	34 - 37
Thermostat w/shutoff & diverter	Mitigeur thermostatique avec robinet d'arrêt et inverseur	Termostato con llave de paso y distribuidor	38 - 40
Pressure balance valve	Mitigeur équilibrage de pression	Válvula de presión balanceada	34 - 36, 41
Pressure balance w/diverter	Mitigeur équilibrage de pression avec inverseur	Válvula de presión balanceada con distribuidor	42 - 44
Axor Urquiola 11435xx1			30
Raindance 28411xx1			31
Raindance 27373xx1			32
Raindance 28417xx1, 28403xx1			33
Raindance 28433xx1			37
Raindance S Showerpipe 27192xx1			45

## Symbols used:

	hot water	eau chaude	agua caliente
	cold water	eau froide	agua fría
	reinforce wall at this location	le mur n'a pas besoin d'être renforcé à cet endroit	en este sector es necesario un refuerzo del muro
	thermostatic mixer	mitigeur thermostatique	termostato
	thermostat w/shutoff	mitigeur thermostatique avec robinet d'arrêt	termostato con llave de paso
	thermostat w/shutoff & diverter	mitigeur thermostatique avec robinet d'arrêt et inverseur	termostato con llave de paso y distribuidor
	pressure balance valve	mitigeur équilibrage de pression	válvula de presión balanceada
	pressure balance valve w/diverter	mitigeur équilibrage de pression avec inverseur	válvula de presión balanceada con distribuidor
	diverter tub spout	bec de baignoire inverseur	surtidor de bañera tipo distribuidor
	tub spout	bec de baignoire	surtidor de bañera
	plug the unused outlet	la sortie non utilisée doit être condamnée avec un bouchon laiton	la salida que no se utiliza debe ser tapada
	Quattro diverter 15930181 or 15936181	Quattro inverseur 15930181 ou 15936181	Quattro distribuidor 15930181 o 15936181

**Symbols used:**

	Trio diverter w/shutoff 15981181	Trio inverseur avec robinet d'arrêt 15981181	Trio distribuidor con llave de paso 15981181
	Trio diverter 15984181	Trio inverseur 15984181	Trio distribuidor 15984181
	volume control valve 15974181 (1/2") or 15977181 (3/4")	robinet d'arrêt 15974181 (1/2") ou 15977181 (3/4")	llave de paso 15974181 (1/2") ou 15977181 (3/4")
	do not use!	n'utilisez pas!	¡no use!



Suggested Installations / Suggestions d'installation / Sugerencias de instalación

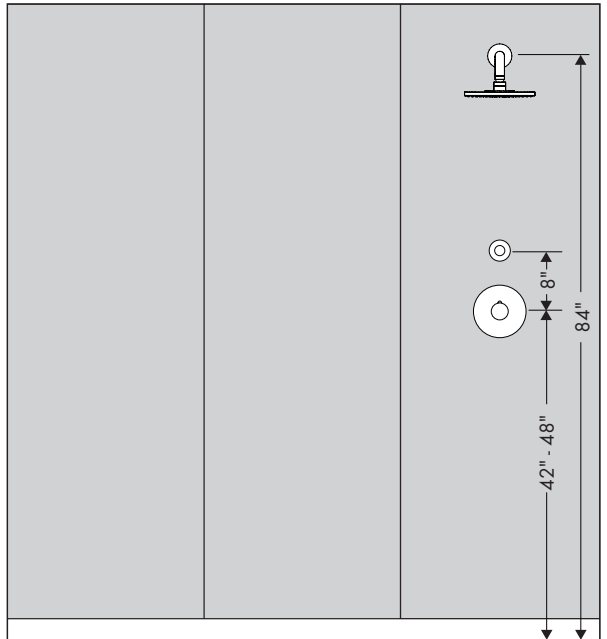
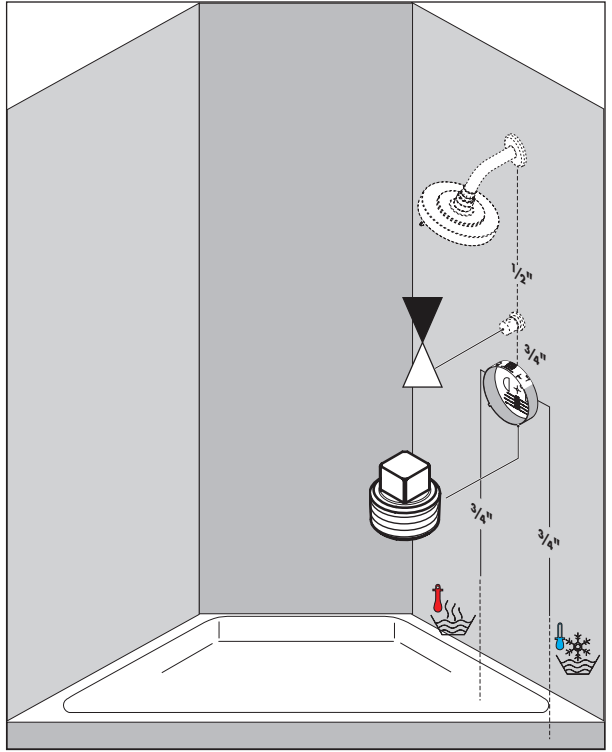
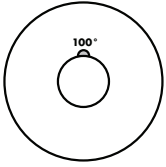

Suggested Installations / Suggestions d'installation / Sugerencias de instalación

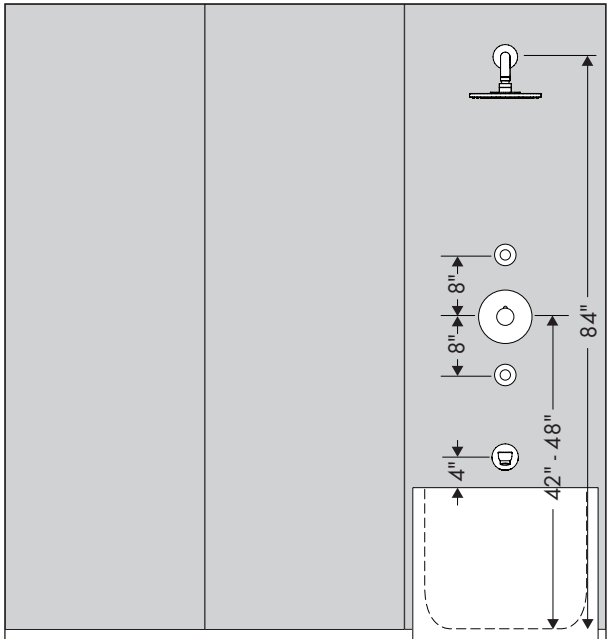
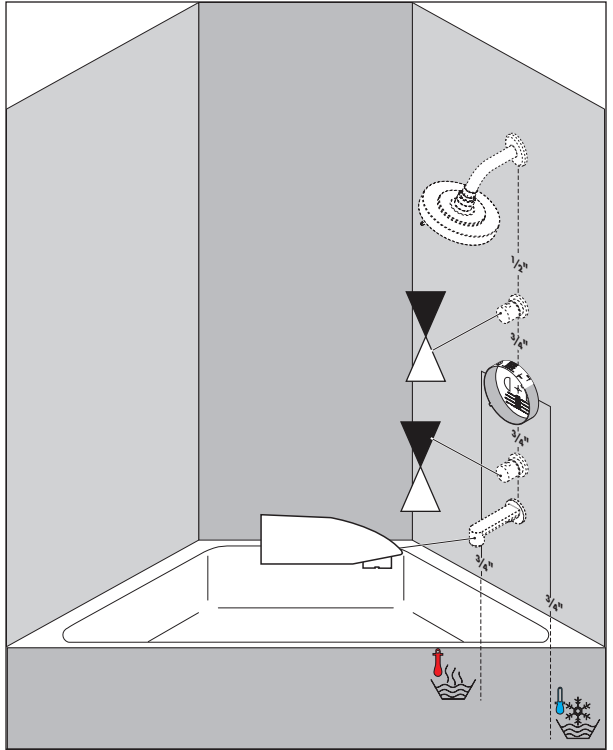
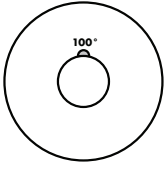

**Suggested Installations / Suggestions d'installation / Sugerencias de instalación**

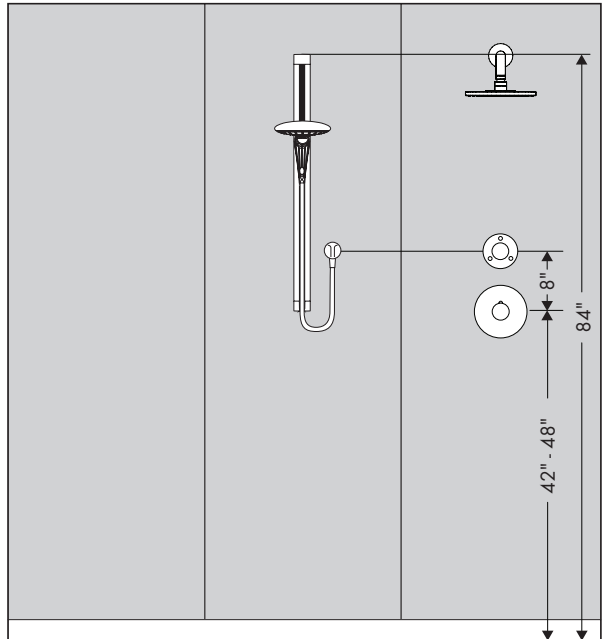
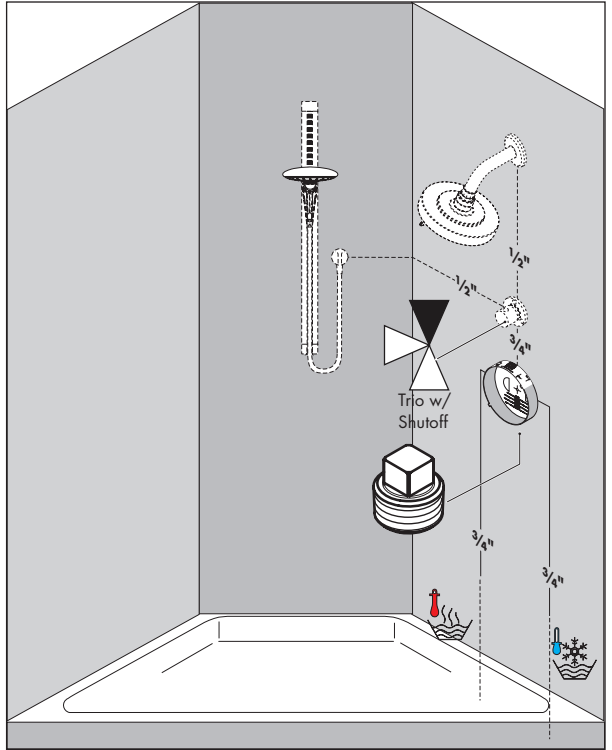
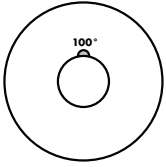

**Suggested Installations / Suggestions d'installation / Sugerencias de instalación**

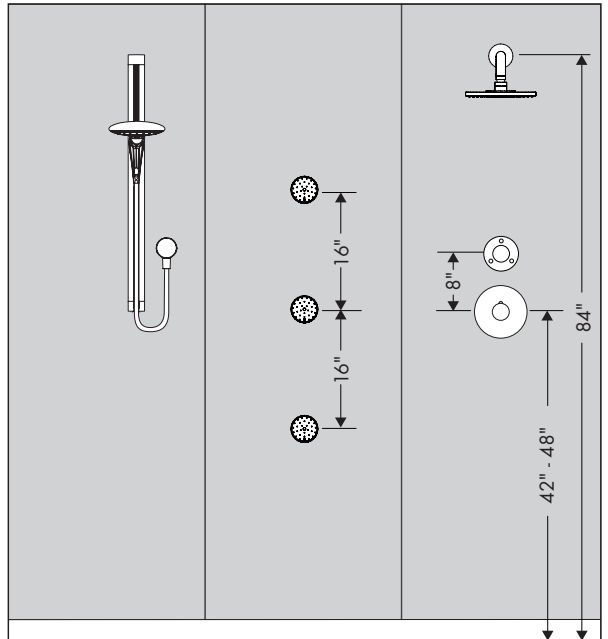
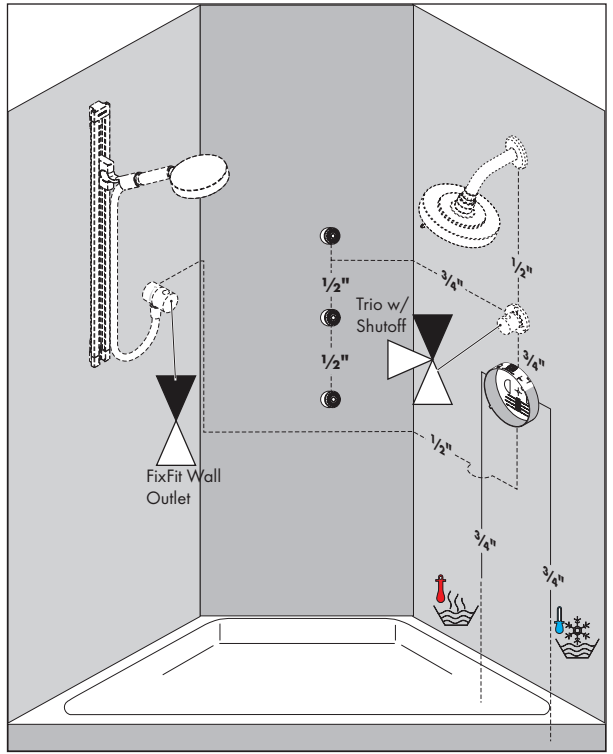
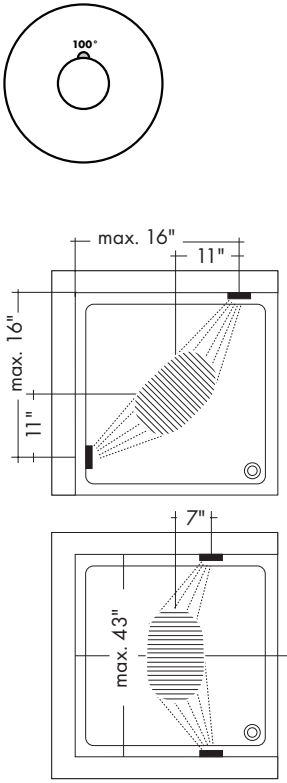

**Suggested Installations / Suggestions d'installation / Sugerencias de instalación**

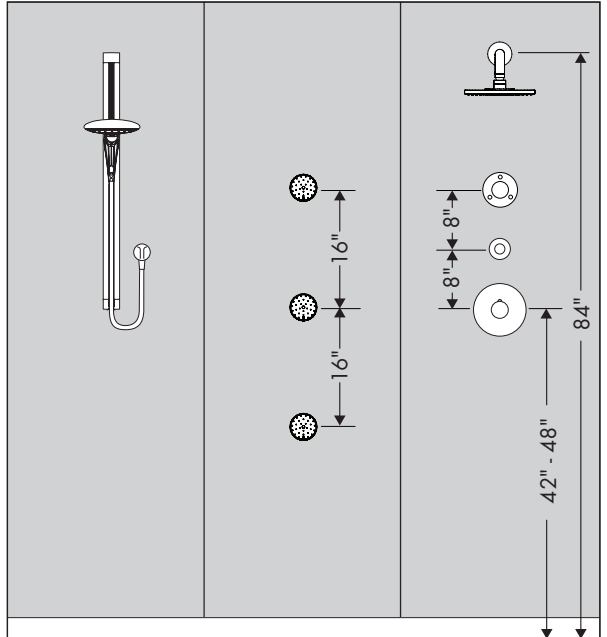
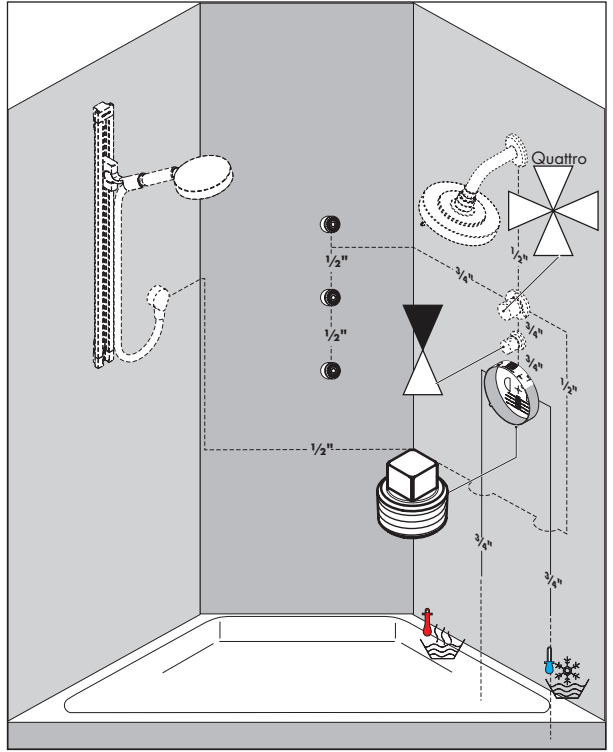
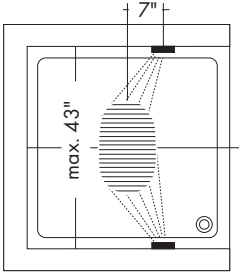
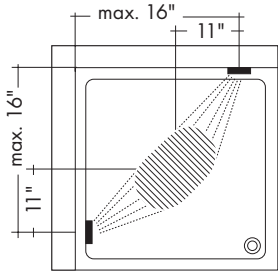
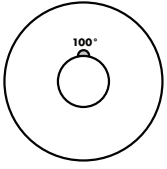

Suggested Installations / Suggestions d'installation / Sugerencias de instalación

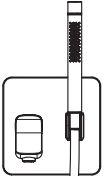
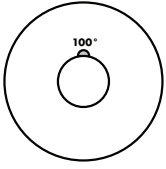

Axor Urquiola  
11435xx1

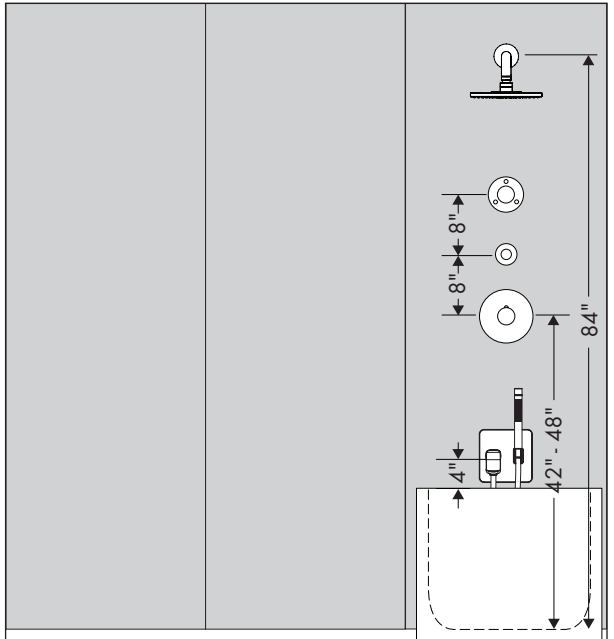
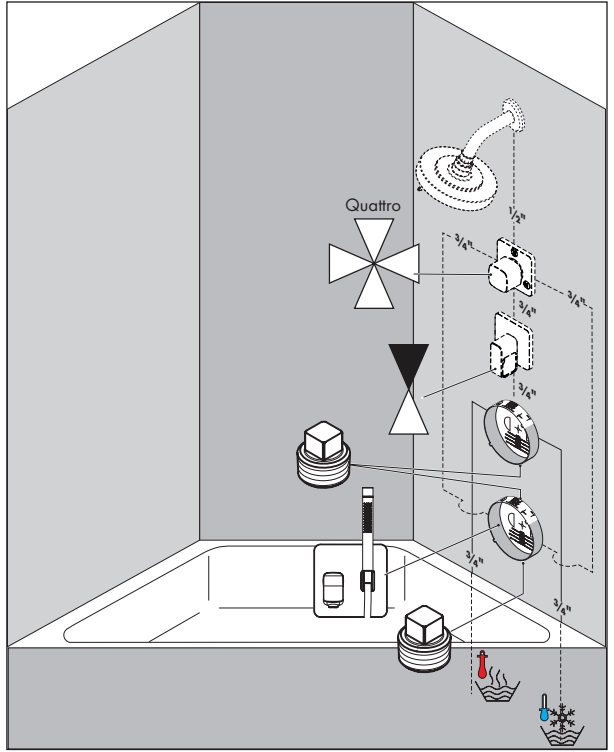

**Suggested Installations / Suggestions d'installation / Sugerencias de instalación**

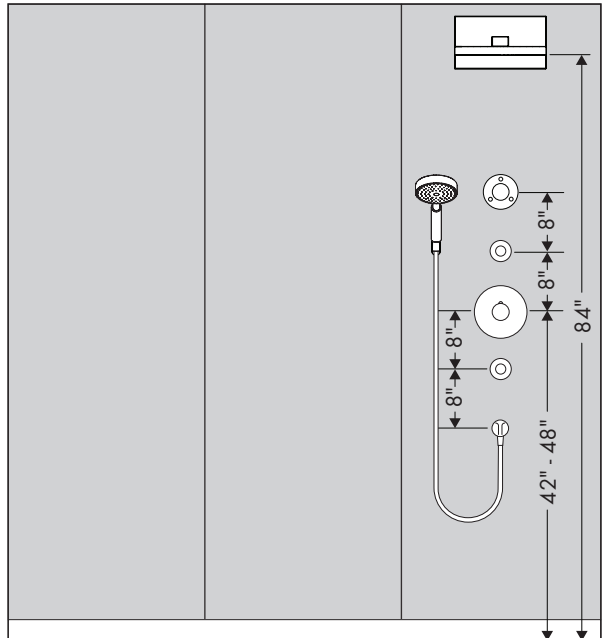
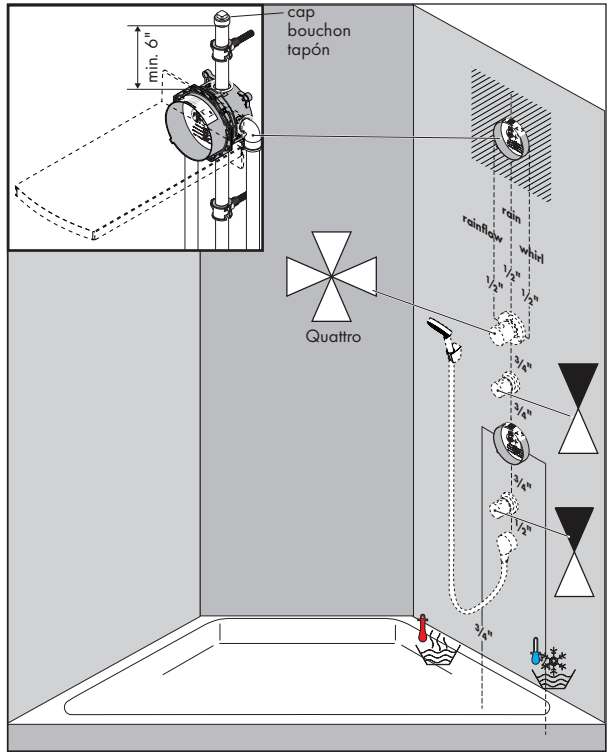
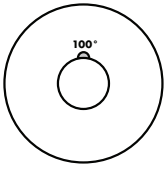

**Suggested Installations / Suggestions d'installation / Sugerencias de instalación**

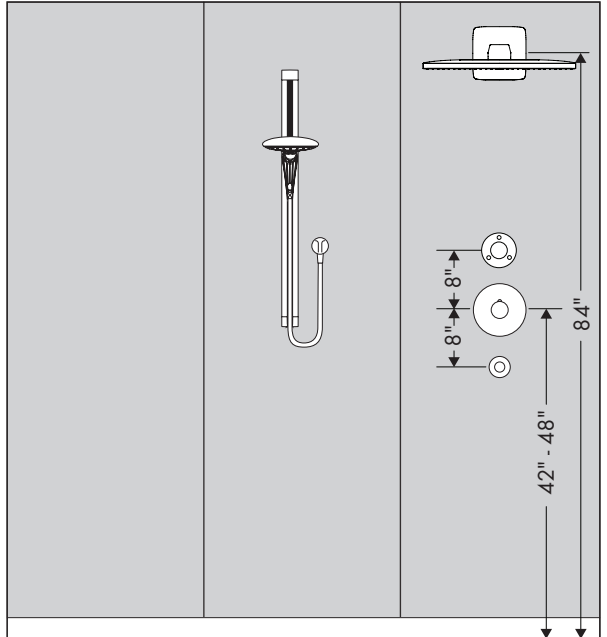
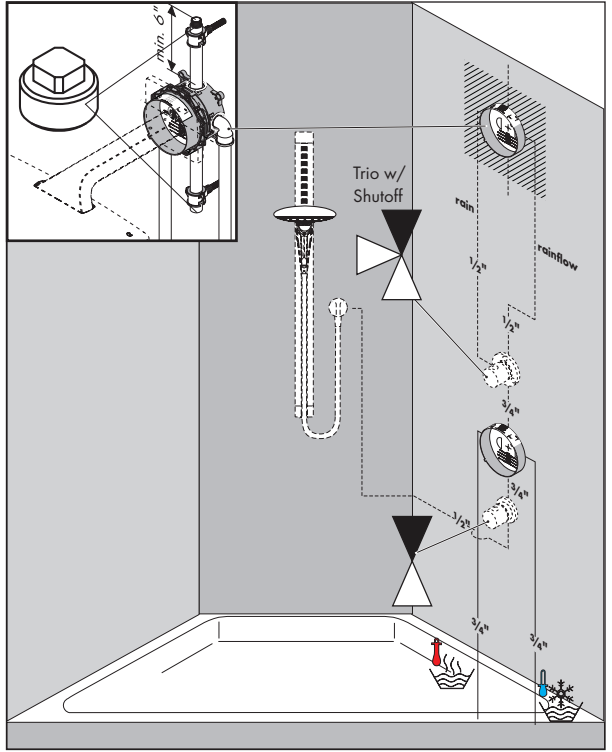
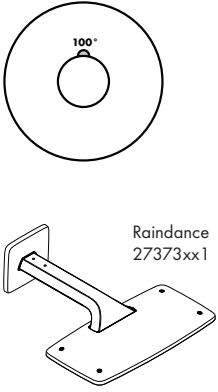



**Suggested Installations / Suggestions d'installation / Sugerencias de instalación**

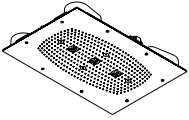
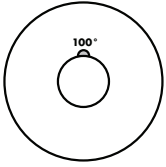

Raindance Imperial 600 AIR  
28417001

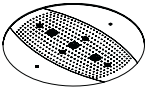

Raindance Imperial 600 AIR  
28403001

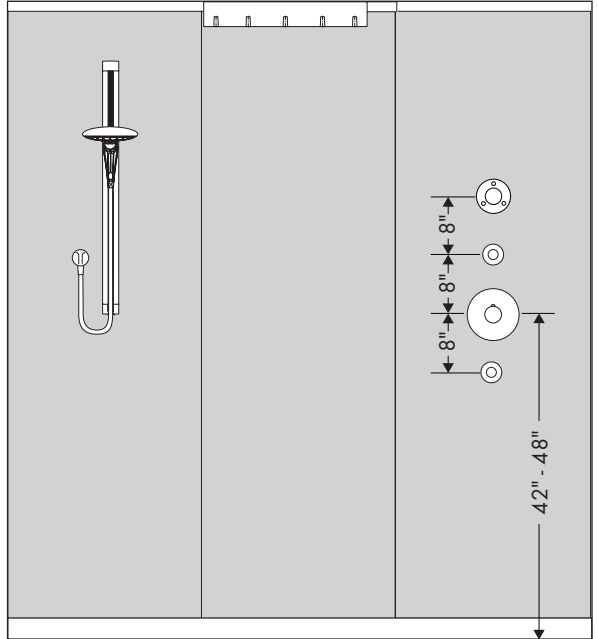
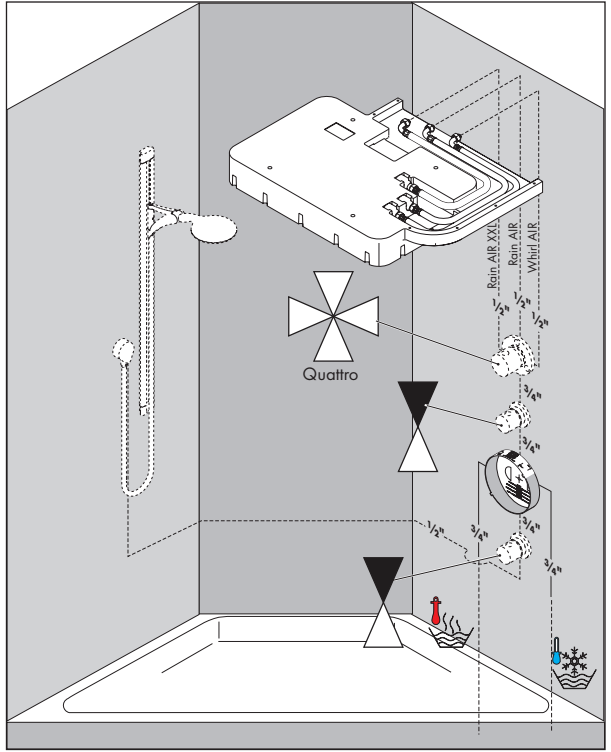

**Suggested Installations / Suggestions d'installation / Sugerencias de instalación**

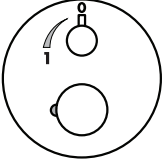

**or / o / ou**

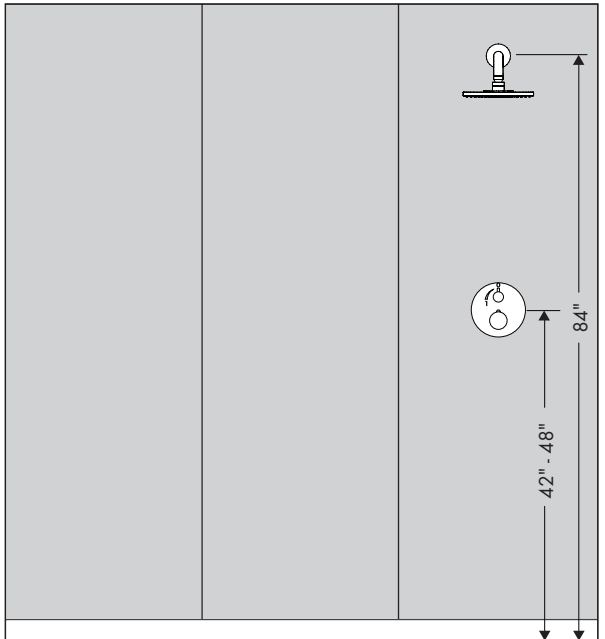
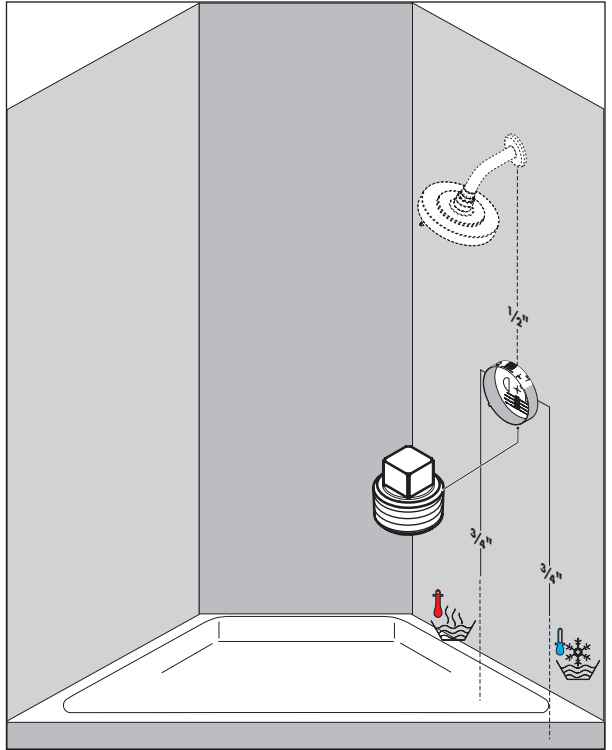
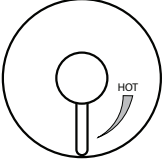

**Suggested Installations / Suggestions d'installation / Sugerencias de instalación**

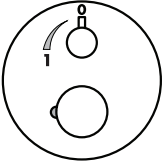

**or / o / ou**

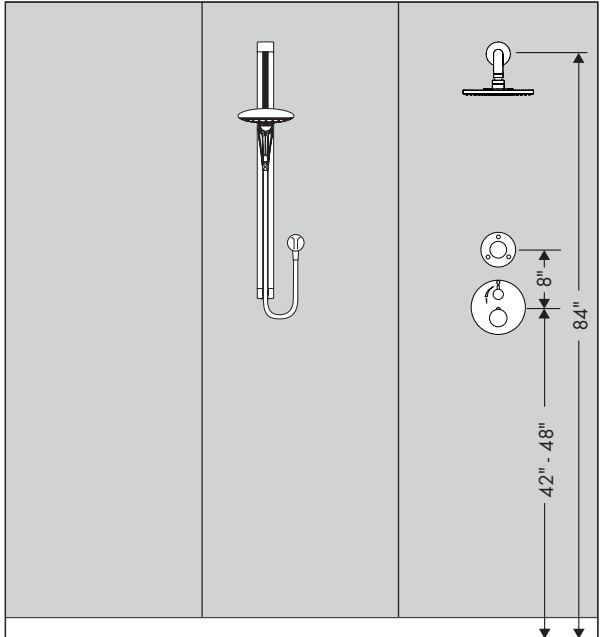
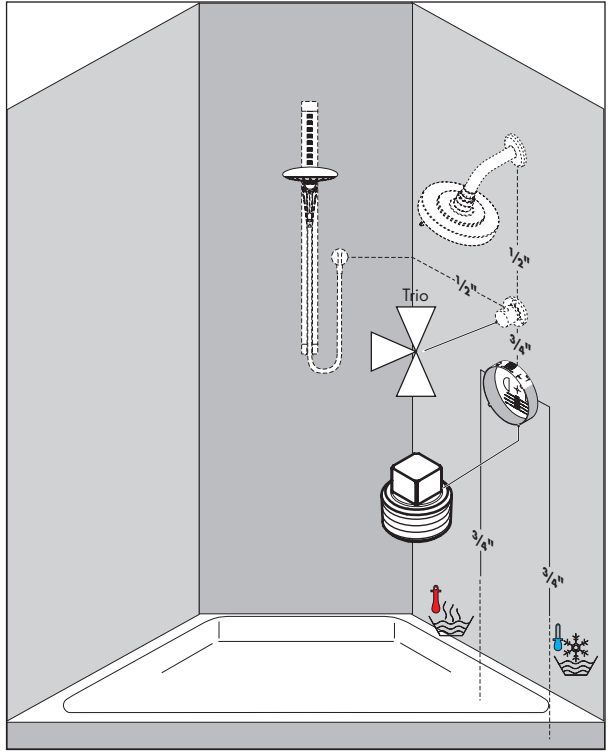
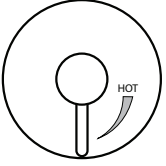

**Suggested Installations / Suggestions d'installation / Sugerencias de instalación**

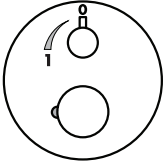

**or / o / ou**

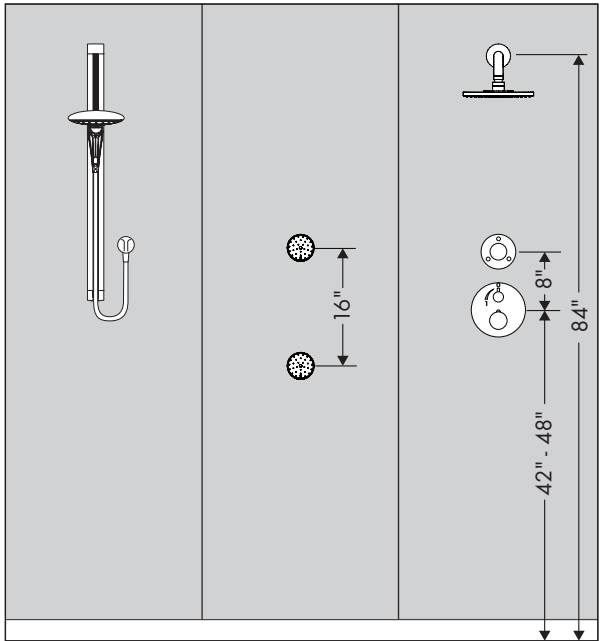
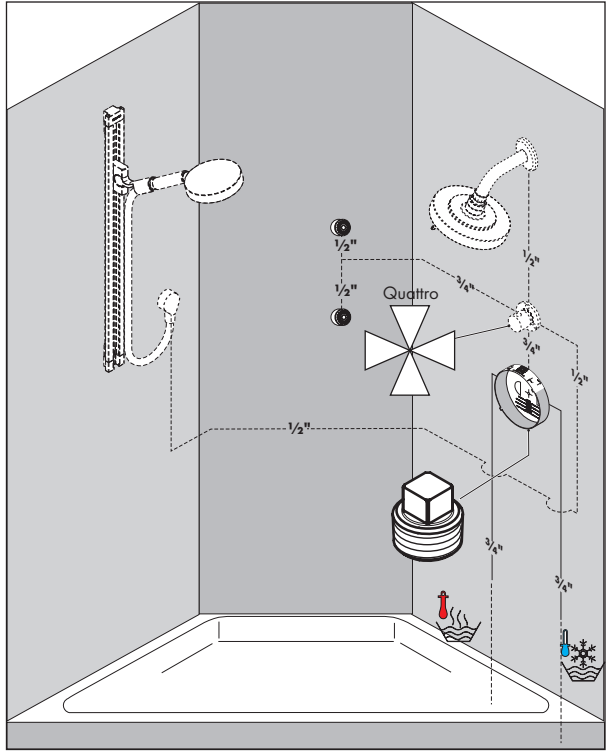
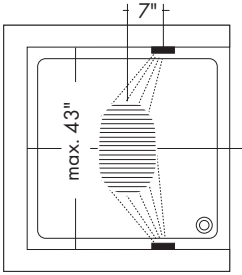
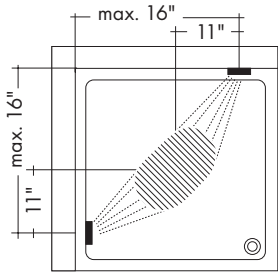
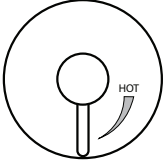

**Suggested Installations / Suggestions d'installation / Sugerencias de instalación**

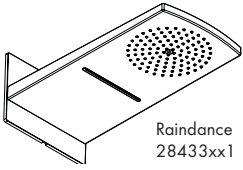
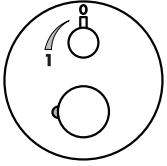

Raindance  
28433xx1

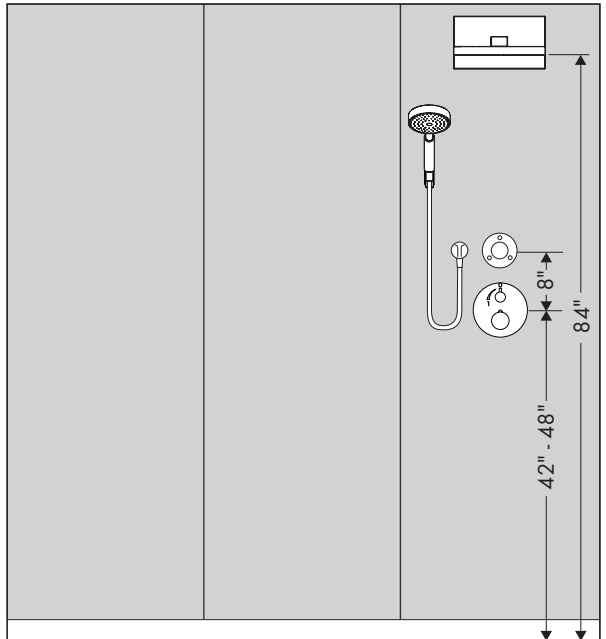
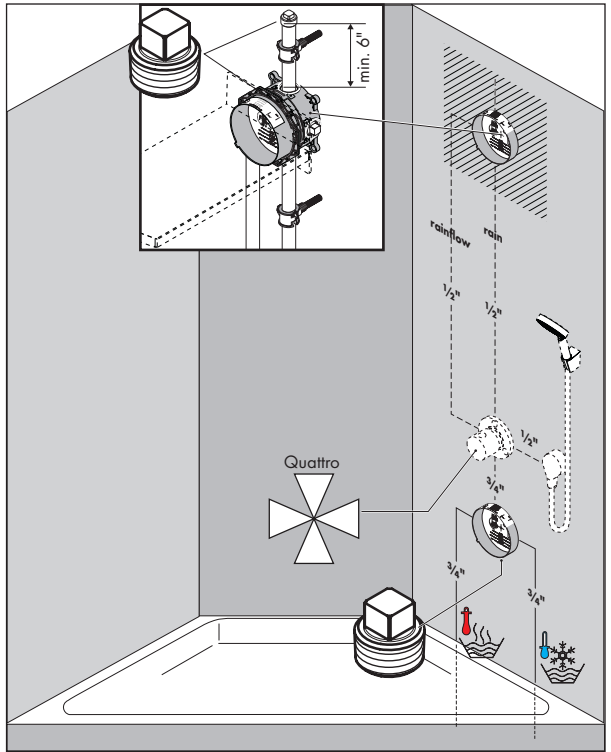



**Suggested Installations / Suggestions d'installation / Sugerencias de instalación**

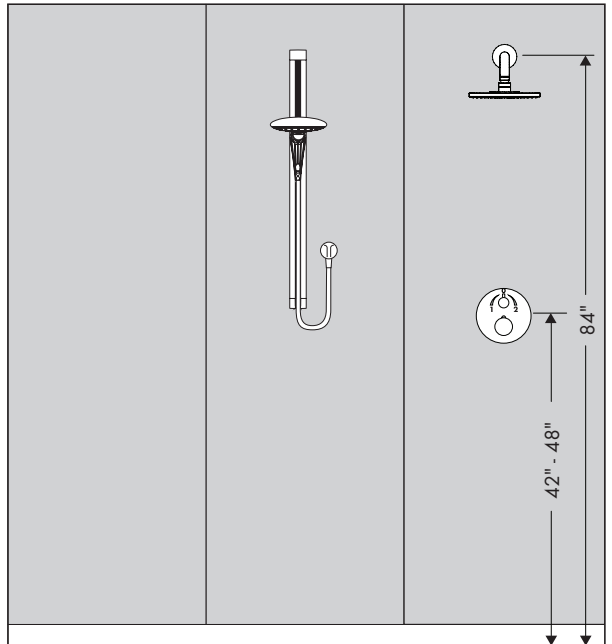
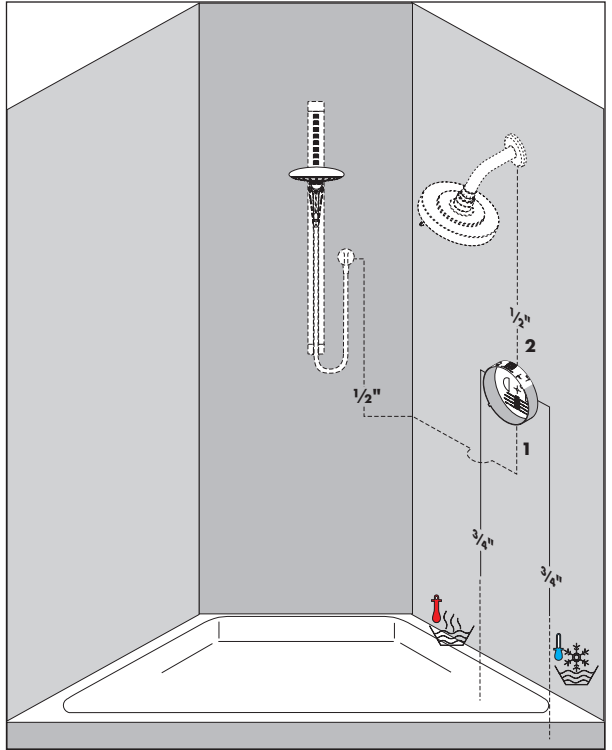
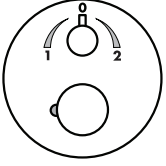

**Suggested Installations / Suggestions d'installation / Sugerencias de instalación**

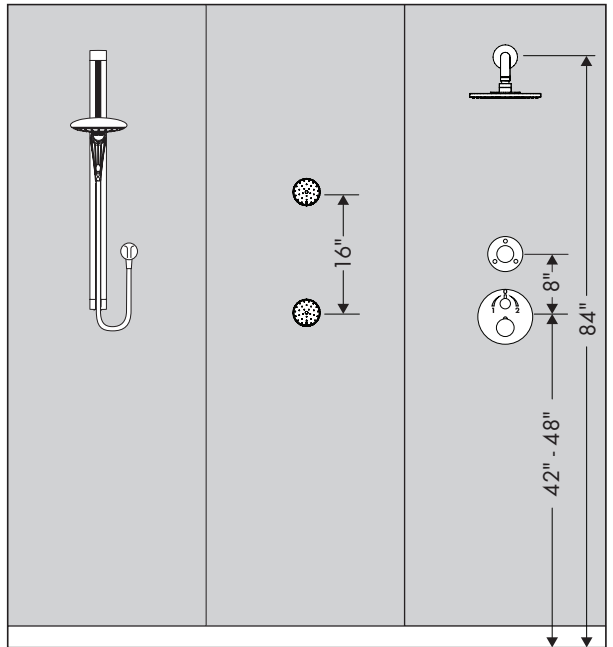
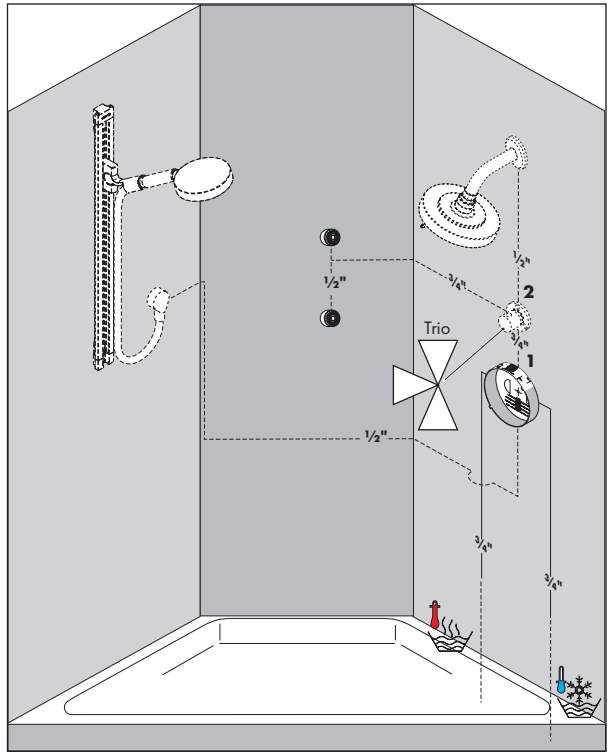
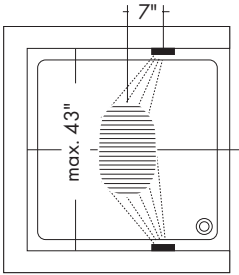
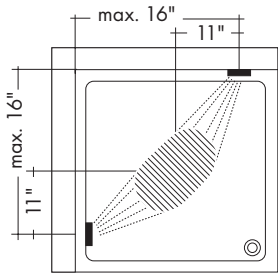
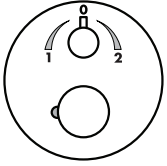



**Suggested Installations / Suggestions d'installation / Sugerencias de instalación**

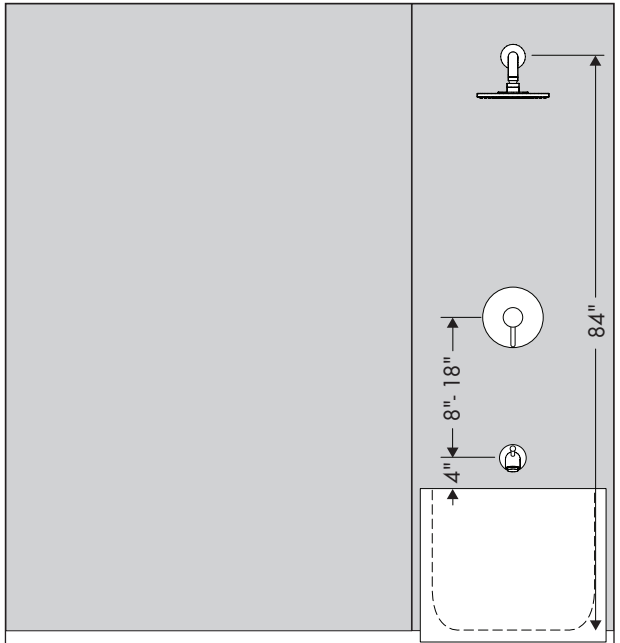
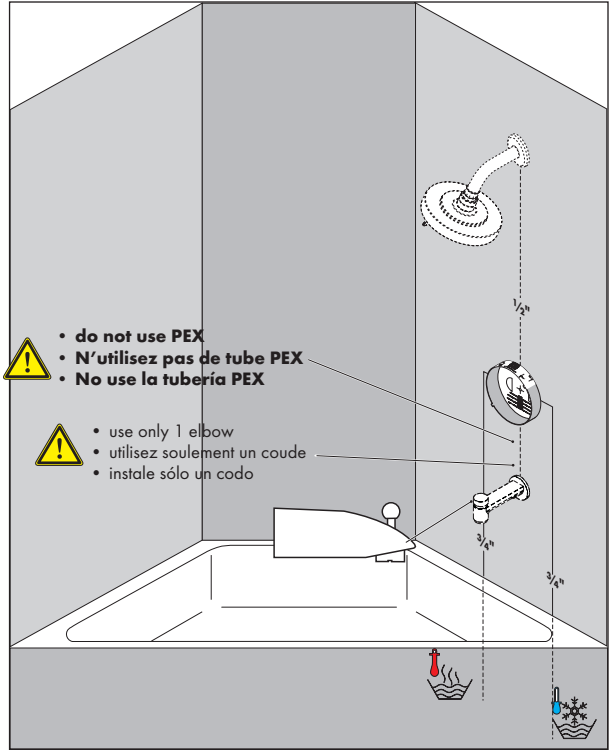
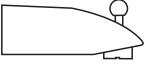
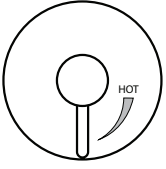

Suggested Installations / Suggestions d'installation / Sugerencias de instalación

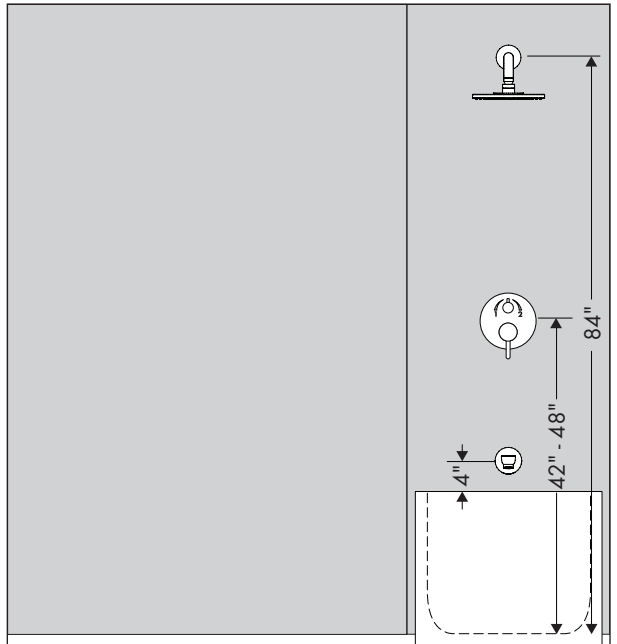
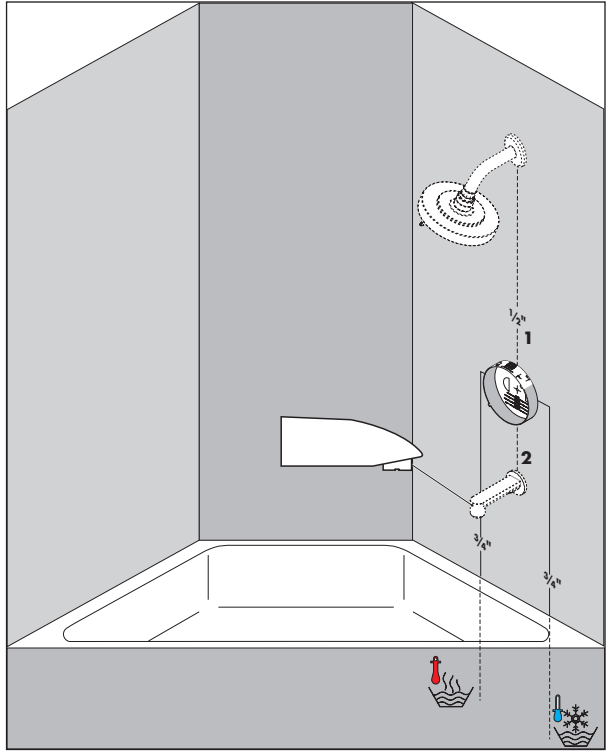
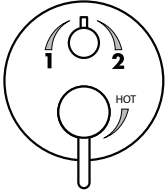

Suggested Installations / Suggestions d'installation / Sugerencias de instalación

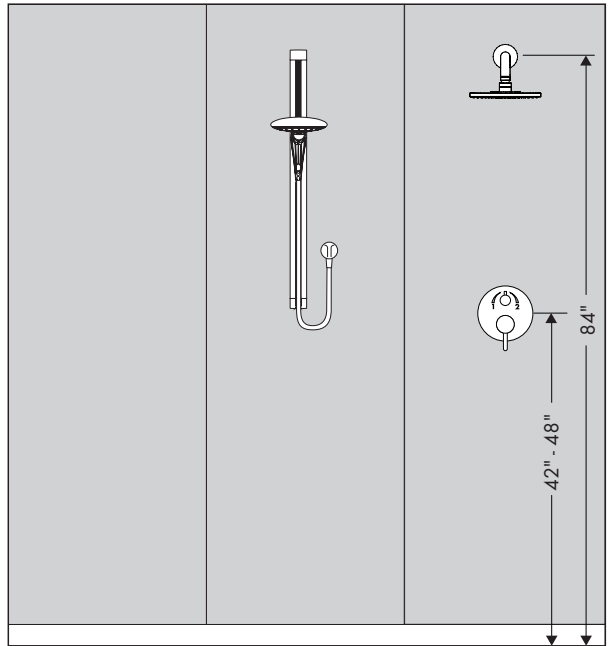
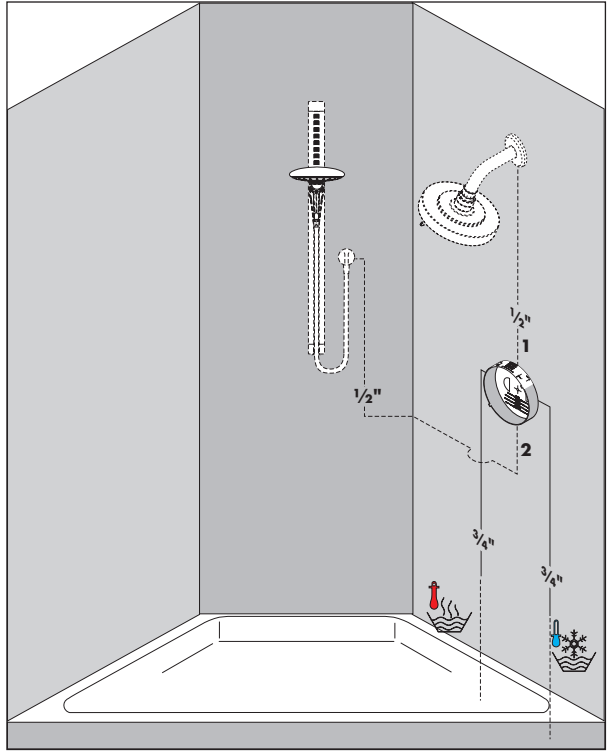
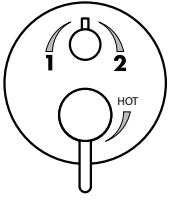

**Suggested Installations / Suggestions d'installation / Sugerencias de instalación**

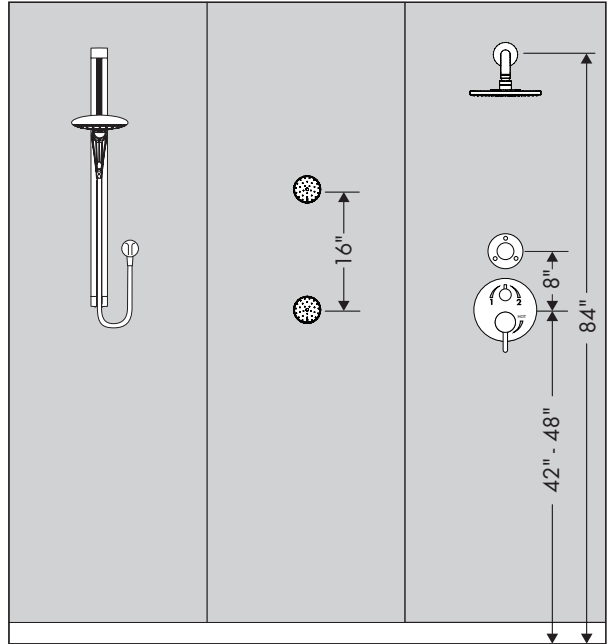
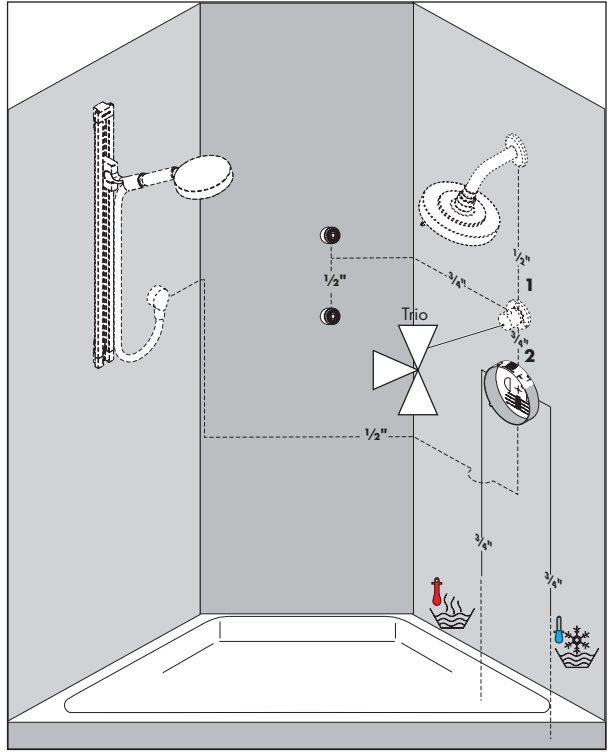
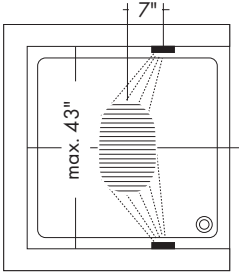
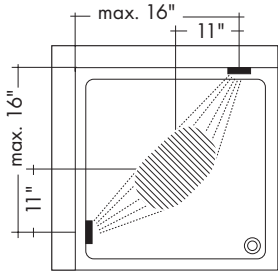
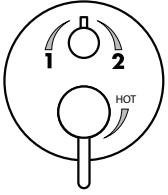

**Suggested Installations / Suggestions d'installation / Sugerencias de instalación**

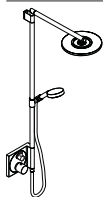

Raindance S  
27192xx1

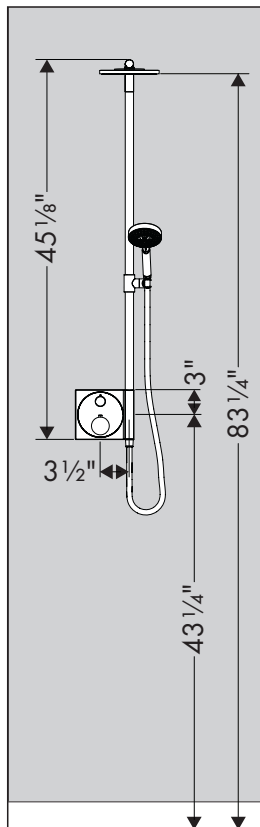
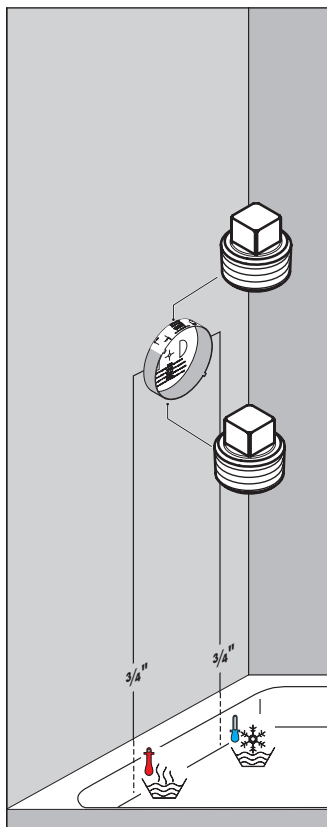

---

## Limited Consumer Warranty

This product has been manufactured and tested to the highest quality standards by Hansgrohe, Inc. ("Hansgrohe"). This warranty is limited to Hansgrohe products that are purchased by a consumer in the United States or Canada after March 1, 1996, and installed in either in the United States or in Canada.

### WHO IS COVERED BY THE WARRANTY

This warranty extends to the original purchaser only. This warranty is non-transferable.

### WHAT IS COVERED BY THE WARRANTY

The warranty covers only your Hansgrohe manufactured product. Hansgrohe warrants this product against defects in material or workmanship as follows:

Hansgrohe will replace at no charge for parts only or, at its option, replace any product or part of the product that proves defective because of improper workmanship and/or material, under normal installation, use, service and maintenance. If Hansgrohe is unable to provide a replacement and repair is not practical or cannot be made in timely fashion, Hansgrohe may elect to refund the purchase price in exchange for the return of the product.

### LENGTH OF WARRANTY

Replacement or repaired parts of products will be covered for the term of this warranty, as stated in the following two sentences. If you are a consumer who purchased the product for use primarily for personal, family or household purposes, this warranty extends for as long as you own the product and the home in which the product is originally installed. If you purchased the product for use primarily for any other purpose, including, without limitation, a commercial purpose, this warranty extends only (i) for 1 year, with respect to Hansgrohe & Commercial products, and (ii) for 5 years, with respect to Axor products.

### THIS WARRANTY DOES NOT COVER, AND HANSGROHE WILL NOT PAY FOR:

- A. Conditions, malfunctions or damage not resulting from defects in material or workmanship.
- B. Conditions, malfunctions or damage resulting from (1) normal wear and tear, improper installation, improper maintenance, misuse, abuse, negligence, accident or alteration; (2) the use of abrasive or caustic cleaning agents or "no-rinse" cleaning products, or the use of the product in any manner contrary to the product instructions; or (3) conditions in the home such as excessive water pressure or corrosion.
- C. Labor and other expenses for disconnection, deinstallation, or return of the product for warranty service (including but not limited to proper packaging and shipping costs), or for installation or reinstallation of the product.
- D. Accessories, connected materials and products, or related products not manufactured by Hansgrohe.
- E. Any Hansgrohe or Axor product sold for display purposes.
- F. Rubbed Bronze finish is subject to a 3-year limited warranty. Chrome and all PVD finishes are covered by the limited lifetime warranty.
- G. Hansgrohe Water Filtration System is subject to a 1-year limited warranty. Warranty does not include replacement filters.

### TO OBTAIN WARRANTY PARTS OR INFORMATION

Contact your Hansgrohe retailer, or contact Technical Service at:

Hansgrohe, Inc.  
1492 Bluegrass Lakes Parkway  
Alpharetta, GA 30004  
Toll-free 800-334-0455

In requesting warranty service, you will need to provide:

1. The sales receipt or other evidence of the date and place of purchase.
2. A description of the problem.
3. Delivery of the product or the defective part, postage prepaid and carefully packed and insured, to:

Hansgrohe, Inc.  
1492 Bluegrass Lakes Parkway  
Alpharetta, GA 30004  
Toll-free 800-334-0455

When warranty service is completed, any repaired or replacement product or part will be returned to you postage prepaid.

### EXCLUSIONS AND LIMITATIONS

**REPAIR OR REPLACEMENT (OR, IN LIMITED CIRCUMSTANCES, REFUND OF THE PURCHASE PRICE) AS PROVIDED UNDER THIS WARRANTY IS THE EXCLUSIVE REMEDY OF THE PURCHASER. HANSGROHE NEITHER ASSUMES NOR AUTHORIZES ANY PERSON TO CREATE FOR IT ANY OTHER OBLIGATION OR LIABILITY IN**

---

**CONNECTION WITH THIS PRODUCT. HANSGROHE SHALL NOT BE LIABLE TO PURCHASER OR ANY OTHER PERSON FOR ANY INCIDENTAL, SPECIAL OR CONSEQUENTIAL DAMAGES, ARISING OUT OF BREACH OF THIS WARRANTY OR ANY IMPLIED WARRANTY (INCLUDING BUT NOT LIMITED TO ANY IMPLIED WARRANTY OF MERCHANTABILITY).**

Some States do not allow the exclusion or limitation of incidental or consequential damages, so the above limitation or exclusion may not apply to you. This warranty gives you specific legal rights, and you may also have other rights that vary from state to state.

**TO THE EXTENT PERMITTED BY LAW, ANY IMPLIED WARRANTIES OF MERCHANTABILITY AND FITNESS FOR A PARTICULAR PURPOSE, ARE LIMITED TO THE DURATION OF THE EXPRESS WARRANTY.**

Some states do not allow limitations on how long an implied warranty may last, so the above limitations may not apply to you. You may be required by law to give us a reasonable opportunity to correct or cure any failure to comply before you can bring any action in court against us under the Magnuson-Moss Warranty Act.

**PRODUCT INSTRUCTIONS AND QUESTIONS**

Upon purchase or prior to installation, please carefully inspect your Hansgrohe product for any damage or visible defect. Prior to installing, always carefully study the enclosed instructions on the proper installation and the care and maintenance of this product. If you have questions at any time about the use, installation or performance of your Hansgrohe product, or this warranty, please write us or call us toll-free at 800-334-0455.

**hansgrohe**

Hansgrohe, Inc. • 1490 Bluegrass Lakes Parkway • Alpharetta, GA 30004  
Tel. 770-360-9880 • Fax 770-360-9887

[www.hansgrohe-usa.com](http://www.hansgrohe-usa.com)