

Features

- Touchless on/off with a wave of your hand or an object such as a pan.
- Response® technology uses a state-of-the-art motion sensor for reliable touchless activation.
- LED light indicates Response® is ready to use.
- AC-powered operation—no batteries to replace.
- Response® technology provides reliable touchless on/off operation through a state-of-the-art sensor that responds in 20 milliseconds.
- Three-function pull-down sprayhead with touch-control allows you to switch between stream, Sweep® spray and BerrySoft® spray.
- Sweep® spray creates a wide, forceful blade of water for superior cleaning.
- BerrySoft® is a light spray ideal for washing hands, rinsing delicate dishware and prepping fruits and vegetables.
- DockNetik® magnetic docking system securely locks sprayhead into place when not in use.
- KOHLER ceramic disc valves exceed industry longevity standards for a lifetime of durable performance.
- ProMotion® technology's light, quiet braided hose and swiveling ball joint make the pull-down sprayhead easier and more comfortable to use.
- MasterClean™ sprayface features an easy-to-clean surface that withstands mineral buildup.
- High-arch rotating spout offers superior clearance for filling pots and cleaning.
- Single lever handle is simple to use and makes adjusting water temperature easy.
- Temperature memory allows faucet to be turned on and off at the temperature set during prior usage.
- 1.5 gpm (5.7 lpm) maximum flow rate at 60 psi (4.14 bar).

Material

- Premium metal construction for durability and reliability.
- KOHLER finishes resist corrosion and tarnishing.

Installation

- Single-hole installation (three-hole escutcheon sold separately).
- Flexible supply lines simplify installation.

Recommended Products/Accessories

K-23723 Faucet cleaner

Optional Products/Accessories

K-99272 Three-Hole Kitchen Faucet Escutcheon

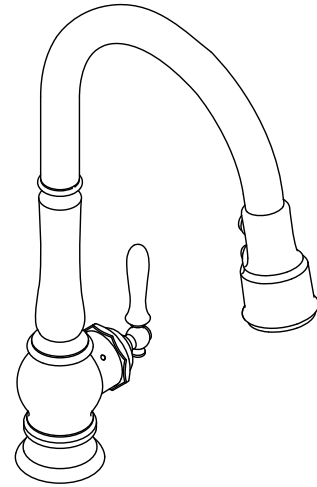

ADA

CSA B651

Codes/Standards

ASME A112.18.1/CSA B125.1

NSF/ANSI 61

NSF/ANSI 372

All applicable US Federal and State material regulations

DOE - Energy Policy Act 1992

California Energy Commission (CEC)

ADA

ICC/ANSI A117.1





CSA B651

**KOHLER® Electronic Faucets,
Valves, and Controls Five-Year
Limited Warranty KOHLER® Faucet
Lifetime Limited Warranty**

See website for detailed warranty information.

Available Colors/Finishes

Color tiles intended for reference only.

Color	Code	Description
	CP	Polished Chrome
	SN	Vibrant® Polished Nickel
	VS	Vibrant® Stainless
	2BZ	Oil-Rubbed Bronze
	2MB	Vibrant® Brushed Moderne Brass

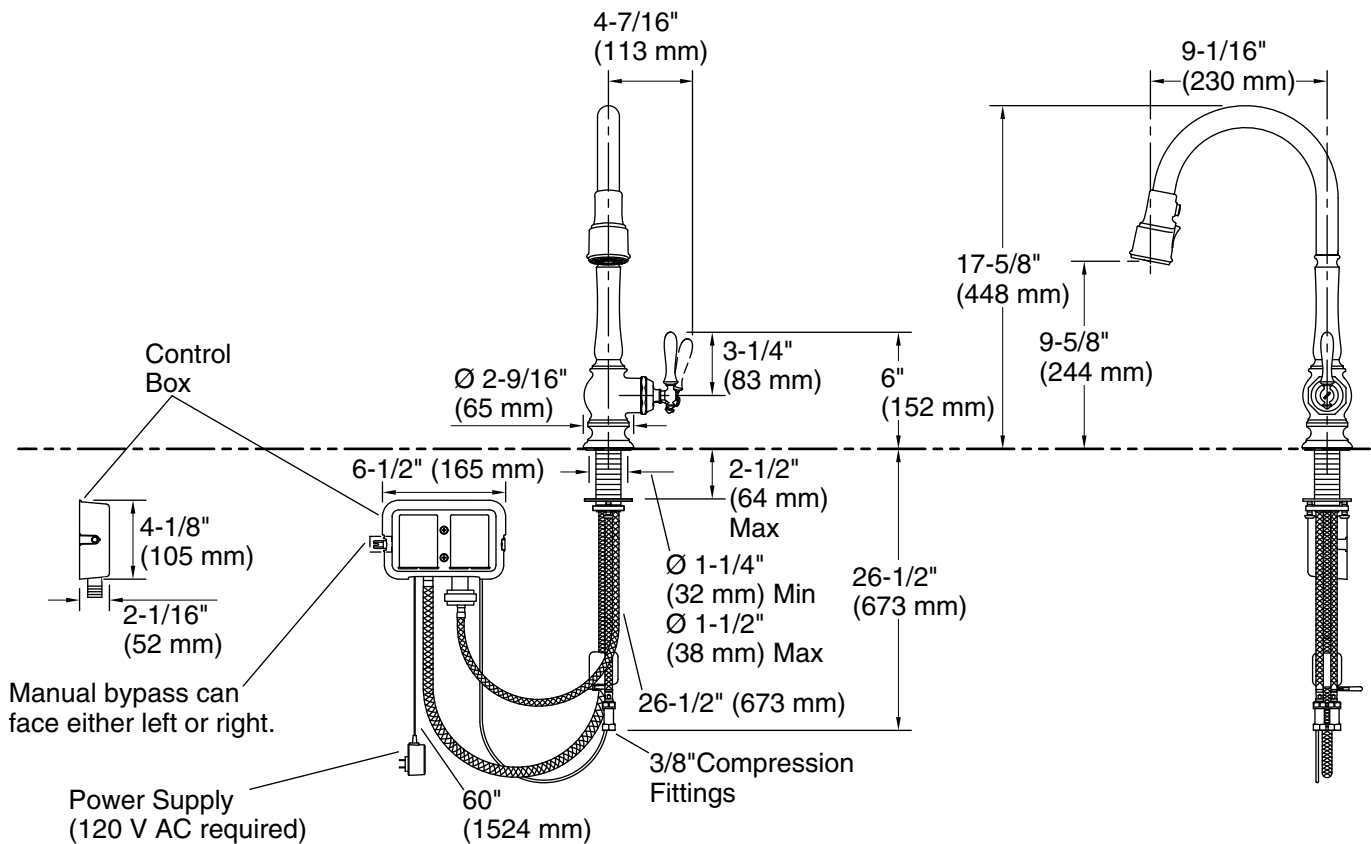

Required Electrical Service

One dedicated circuit required, protected with Class A Ground-Fault Circuit-Interrupter (GFCI). Outside North America, this device may be known as a Residual Current Device (RCD).
120 V, 0.15 A, 50/60 Hz

Technical Information

All product dimensions are nominal.
Power source: Plug - AC, included
Valve body: Plastic
Drain included: No

Spout:

Spout reach: 9-1/16" (231 mm)

Notes

Install this product according to the installation instructions.

REQUIRED: Unswitched power outlet (120 V AC) located below the sink and within 5' (1.5 m) of the control box. (Garbage disposals typically use switched outlets and are not recommended.)

ADA complaint for faucet handles only.

ADA, CSA B651 compliant when installed to the specific requirements of these regulations.