

# NEWPORT BRASS VALVE

## Features

- Solid brass construction
- Universal 3/4" NPT and direct sweat connections for installation flexibility
- 22 gpm (gallons per minute) flow rate (@ 40 psi) dynamic pressure
- Quarter-turn washerless ceramic disc 3/4" valve cartridges.
- Quick Conect Deck Spout Adapter
- Diverter valve and hoses as needed for handshower
- Requires Newport Brass Deck Mount
- Tub Trim (many options available, sold-separately)

## Codes / Standards Compliance

Meets or exceeds the following at date of manufacture:

- ASME A112.18.1/CSA B125.1
- IAPMO/Cupc
- IPC
- ASSE 1016
- All applicable US Federal and State material regulations

## Deck Tub Rough Valve

# 1-548

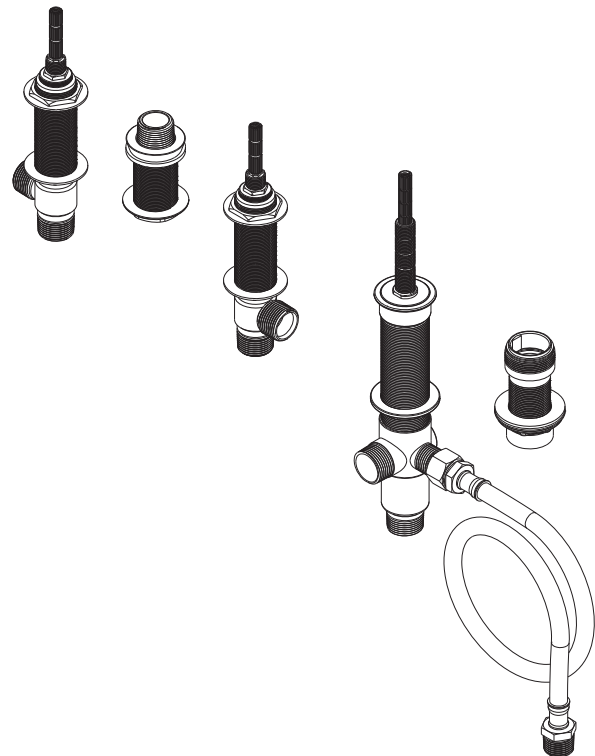

## Specified Model

Model	Description	Colors   Finishes
1-548	Deck Tub Rough Valve w/Hand Shower	<input type="checkbox"/> NA

## Product Specification: Add "Color / Finish" suffix to Model number, below.

The deck mount valve for tub with handshower installations shall be made of solid brass construction. Valve body shall have universal 3/4" NPT connections Valve body shall incorporate quarter-turn washerless ceramic disc valve cartridges. Valve shall have a maximum flow rate of 22 gpm (gallons per minute) flow rate (@ 40 psi) dynamic pressure. Rough Valve for deck mount trim shall also include a quick-connect spout fitting and Diverter valve with hoses as needed for handshower Rough Valve for deck mount trim installations shall be Newport Brass Model 1-548.

# 1-548

## PRODUCT DIMENSIONS *(Units are in inches)*

