

37-1X-BL2

2 Handle Monoblock

Flow Rate: 1.2 GPM

Specify up to 4" Escutcheon extension when ordering

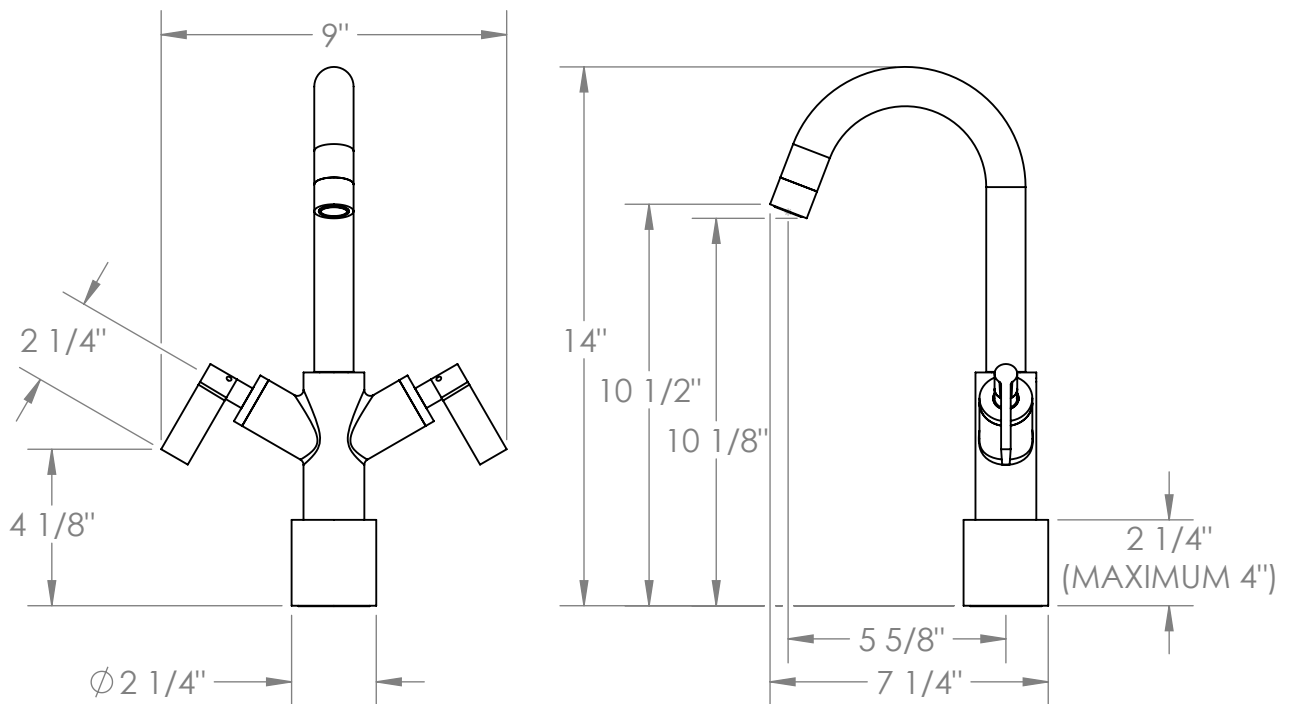

Meets the applicable requirements of ASME A112.18.1-2005/CSA B125.1-05, entitled "Plumbing Supply Fittings"

WATERMARK DESIGNS 11/17/2020

350 Dewitt Ave Brooklyn NY 11207 USA T 718 257 2800 F 718 257 2144 info@watermark-designs.com