

WYNDHAM COLLECTION

Exterior Size - 59"L x 32"W x 23"H
Interior Size - 57"L x 30"W x 17"H
Depth at Drain - 17"
Drain To Overflow - 14"
Maximum Fill - 63-1/2 Gallons
Note - All Measurements are $\pm 1/2$ "

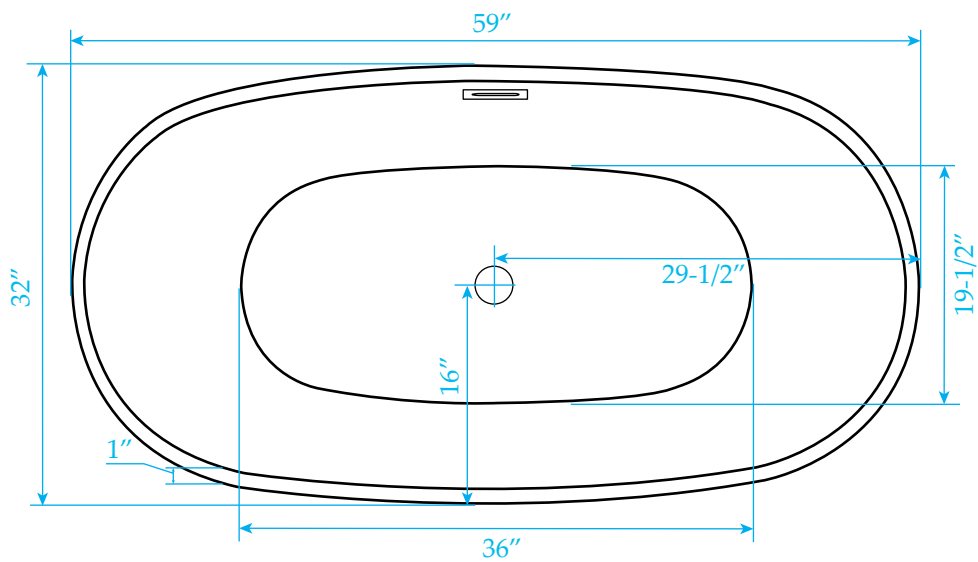
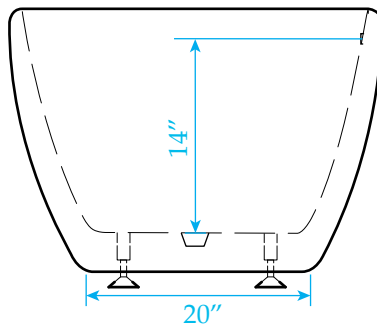
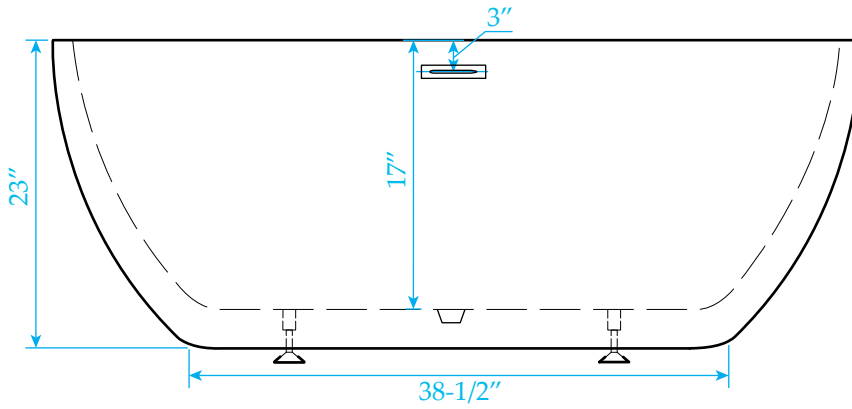

WC-BTE1561-59